

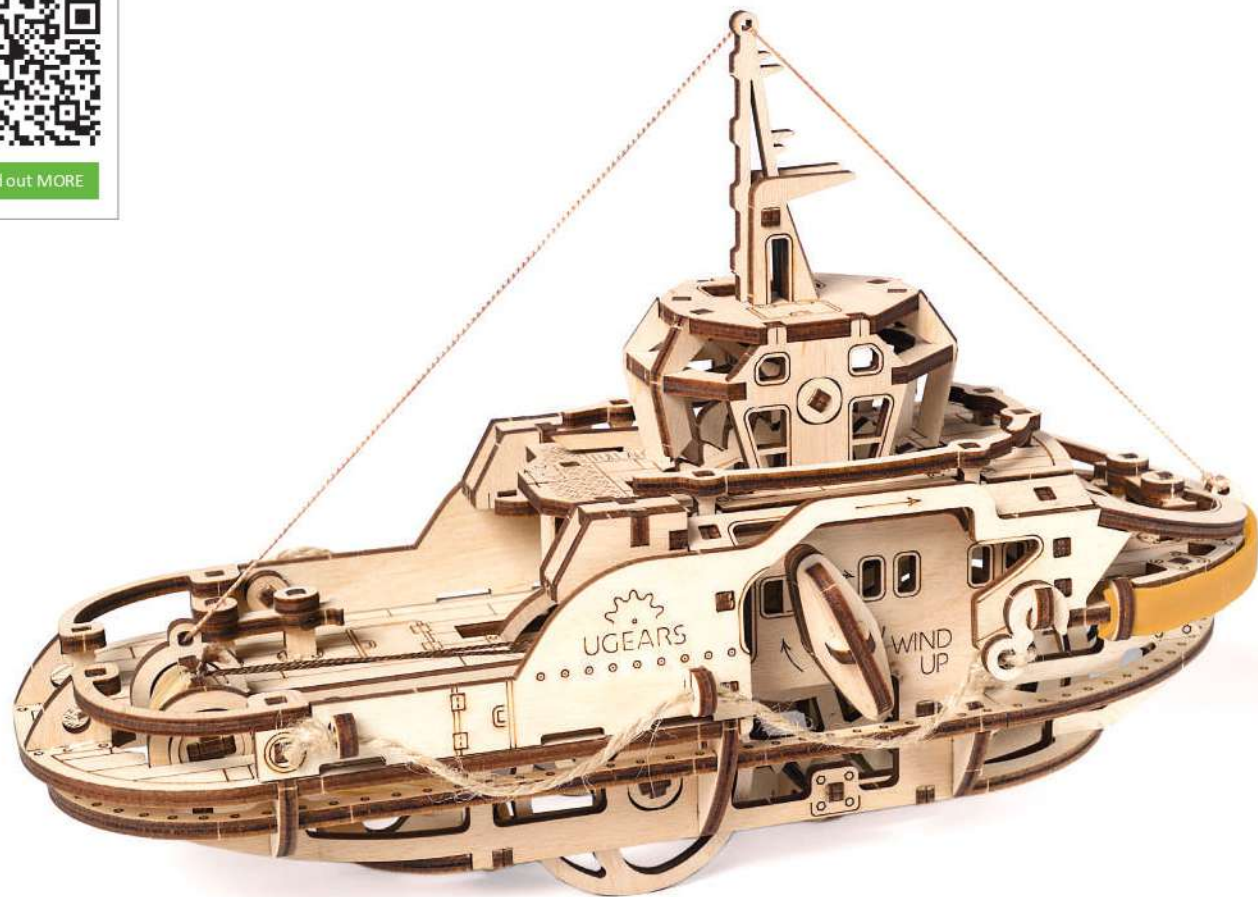

Find out MORE



UGEAR'S®

Mechanical models

Model «Tugboat» Модель «Буксир»

DEU Modell «Schleppschiff». FRA Modèle «Remorqueur».
POL Model «Holownik». SPA Modelo «Remolcador».
ITA Modello «Rimorchiatore». RUS Модель «Буксир».
JAP タグボート. KOR 예인선. CHI 拖船

Assembly instructions Інструкція зі складання

DEU Aufbauanleitung. FRA Notice d'assemblage. POL Instrukcja montażu.
SPA Instrucciones de montaje. ITA Istruzioni di montaggio.
RUS Инструкция по сборке. JAP 組み立て説明書
KOR 조립 설명서. CHI 装配说明书

Assemble Me. Master Harbors with Me



NATURAL
Made from wood materials



NO GLUE CONNECTION
Assembling without glue
and chemicals



SELF ASSEMBLY
Details are already cut
and ready to assemble



MECHANICAL
The models produce motion



EDUCATIONAL
Perfect for Servo projects
through hands-on STEAM learning

ENG

Assembly instructions:
Remove model parts from the hanger board as illustrated below. Careful not to break parts. If a part does not remove easily, carefully cut it out with a knife. This model is intended for self-assembly without glue. If you have difficulty installing the axles, try waxing them with a regular candle. All moving parts can also be waxed during assembly to reduce friction when operating the model.

ITA

Istruzioni di montaggio:
Estrarre dal telaio i particolari indicati nello schema. Fare attenzione a non romperli. Se un particolare non si stacca, tagliare delicatamente gli elementi di collegamento con un coltello. L'assieme viene realizzato senza colla. In caso di difficoltà nell'inserimento di un perno in legno, è necessario sfregare il perno o il particolare con un po' di cera. Per uno scorrimento migliore incerare le parti mobili del meccanismo durante l'assemblaggio.

UKR

Інструкція зі складання:
Витягніть з дошки позначені на схемі деталі. Намагайтеся їх не зламати. Якщо деталь не виймається, надсічіть перемички ножом. Конструкція збирається без клею. У разі виникнення труднощів з протягуванням зубчистки (вісі) в отвір, потріть зубчистку об звичайну свічку. Також можна змастити свічкою всі деталі механізму, що рухаються, щоб зменшити тертя при обертанні.

RUS

Инструкция по сборке:
Вынимайте из доски обозначенные на схеме детали. Старайтесь их не сломать. Если деталь не извлекается, надрежьте перемычки ножом. Конструкция собирается без клея. Если возникли трудности с установкой деревянной оси, перед установкой потрите детали об обычную свечу. Для лучшего скольжения смажьте движущиеся детали механизма обычной свечой во время сборки.

DEU

Aufbauanleitung:
Bitte die in der Zeichnung angegebenen Teile aus der Platte herausnehmen. Versuchen Sie bitte diese nicht zu brechen. Wenn sich ein Teil nicht herausnehmen lässt, schneiden Sie die Stege mit dem Messer leicht an. Das Modell wird ohne Klebstoffe zusammengebaut. Lässt sich eine Achse nur schwer in eine Öffnung einführen, reiben Sie diese mit einer Kerze etwas ein. Für besseres Gleiten schmieren Sie alle beweglichen Teile mit einer Kerze.

JAP

組み立て説明書:
部品に傷をつけないように注意しながらボードから外してください。部品が外れにくい場合は連結部分を力ツターで切ってから外すと外しやすいです。本製品は、接着剤がなくても組み立てができるように設計されています。もしアクスル(駆動部)が、歯車の動きがにぶい場合は、ロウソクをアクスルに塗ってください。全ての駆動部分は製品を動かす時、滑らかに動くように潤滑剤であるロウソクを塗りながら組み立てます。

FRA

Notice d'assemblage:
Faites sortir de la planche les pièces comme indiquées sur le schéma. Tâchez de ne pas les casser. Si la pièce ne sort pas, incisez les collages/fixations avec un couteau. La construction est à assembler sans colle. Si il est difficile d'introduire l'axe en bois dans l'orifice, frottez au préalable l'axe ou les pièces contre une bougie. Pour améliorer le glissement, traitez les pièces de frottement mobiles du mécanisme avec une bougie au cours d'assemblage.

KOR

조립 설명:
부품이 손상되지 않도록 주의하여 보드에서 떼어냅니다. 만약 부품이 잘 떨어지지 않으면 연결 부분을 칼로 절단 한 후 떼어내면 쉽게 떼어 낼 수 있습니다. 본 제품은 접착제가 없이 조립이 가능하도록 설계되어 있습니다. 만약 축이 잘 끼워지지 않는 경우 양초를 축에 바른 후 끼워 보세요. 모든 구동 부위는 제품 구동 시 원활한 작동이 가능하도록 조립 과정에서 윤활제(양초)양초를 발라 주세요.

POL

Instrukcja montażu:
Delikatnie wyciągaj z deseczek wiązadła nożem. Konstrukcję składa się bez kleju. Jeśli napotkasz trudności z instalacją drewnianej osi w otwór, potrzyj na początku oś lub detale o woskową świecę. Dla lepszego poślizgu polecamy smarowanie ruchomych części mechanizmu zwykłą świecą podczas montażu.

CHI

装配说明:
将模型部件按插图示,从胶合板取下。小心不要损坏零件。如果取下时候有难度,请用小刀小心的切割连接点。这个产品不需要胶水粘接。如果安装转轴的时候有难度,请用普通的蜡加以润滑。所有的转动部分也需要打蜡润滑。

SPA

Instrucciones de montaje:
Saque de la tabla las piezas marcadas en el esquema. Trate de no romperlas. Si una pieza no se saca, haga una incisión. La construcción va sin pegamento. Si tiene dificultades con la instalación del eje de madera en un agujero, frote primero el eje o las piezas contra una vela. Para un mejor deslizamiento, lubrique durante el montaje las piezas móviles del mecanismo con una vela común.

ENG Warning! **UKR** Увага! **DEU** Achtung! **FRA** Attention! **POL** Uwaga!
SPA Precaución! **ITA** Attenzione! **RUS** Внимание! **JAP** 注意!
KOR 주의! **CHI** 注意!



ENG Do not use a lighted candle! **UKR** Не підпалювати!
DEU Nicht anzünden! **FRA** Ne pas brûler! **POL** Nie podpalać!
SPA ¡No encender! **ITA** Non dare fuoco! **RUS** Не поджигать!
JAP 火のついたロウソクの使用はお止めください。
KOR 불이 붙은 초를 이용하지 마세요!
CHI 请勿点燃, 请勿靠近火源!



ENG Caution! Axles have sharp points! **UKR** Обережно! Гострі деталі!
DEU Vorsicht! Spitze Teile! **FRA** Attention: certaines pièces sont pointues! **POL** Ostrożnie! Ostre części!
SPA ¡Atención! Piezas afiladas! **ITA** Attenzione! Particolari appuntiti!
RUS Осторожно! Острые детали! **JAP** アクスル(駆動部)の鋭い部分にご注意ください。
KOR 축의 뾰족한 부분에 주의하세요!
CHI 注意! 含尖锐部件



ENG Spare parts. **UKR** Запасні деталі. **DEU** Ersatzteile. **FRA** Pièces de rechange.
POL Części zamienne. **SPA** Piezas de repuesto. **ITA** Pezzi di ricambio. **RUS** Запасные детали.
JAP 予備部品 **KOR** 여유 부품입니다. **CHI** 备用件

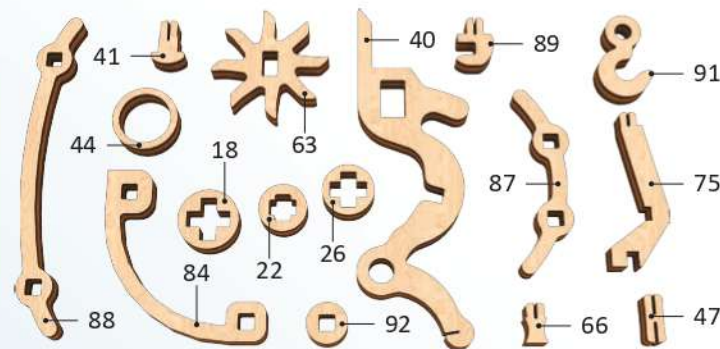



ENG Wax the part with a regular candle (rub with a candle). UKR Змастіть деталь звичайною свічкою (потріть об свічку). DEU Reiben Sie das Teil mit einer einfachen Kerze etwas ein. FRA Lubrifiez la pièce avec une bougie ordinaire (frottez contre la bougie). POL Przesmaruj zwykłą świecą. SPA Engrase la pieza con una vela común (frota con una vela). ITA Incerare il componente (sfregare con la cera). RUS Смажьте деталь обычной свечкой (потрите о свечку). JAP 表示された部分に潤滑剤として口ウソクを塗ってください。KOR 표시된 부분에 윤활을 위해 초를 칠해 주세요. CHI 用普通蜡烛涂抹润滑部件。



ENG Pay attention. Check for correct orientation or positioning. UKR Зверніть увагу. Перевірте розташування елемента. DEU Bitte Beachten. Prüfen Sie die Einbaulage des Elementes. FRA Faites attention. Vérifiez la disposition de l'élément. POL Zwróć uwagę. Sprawdź lokalizację elementu. SPA Atención. Compruebe la situación del elemento. ITA Prestare attenzione. Controllare la posizione del componente. RUS Обратите внимание. Проверьте расположение элемента. JAP 方向及び位置に注意して組み立ててください。KOR 방향 또는 위치에 주의해서 조립해 주세요. CHI 注意！检查部件方向和位置



ENG The part should be easily rotated (moved). UKR Деталь повинна легко крутитися (рухатися). DEU Der Teil soll leicht gedreht (bewegt) werden. FRA La pièce doit tourner (se déplacer) aisément. POL Element powinien łatwo się kręcić (poruszać się). SPA La pieza debe ser fácil de girar (mover). ITA Il componente deve girare (muoversi) facilmente. RUS Деталь должна легко крутиться (двигаться). JAP 部品はしっかりと動かなければなりません。KOR 활하게 움직일 수 있어야합니다. CHI 此部件必须容易的旋转 (移动)



ENG Sand to remove burrs. UKR Видалить задирки. DEU Grate entfernen. FRA Eliminez les bavures. POL Usuń zadziory. SPA Quite las rebabas. ITA Togliere le bave. RUS Удалите заусенцы. JAP バリ取りのサンドペーパー KOR 거친 부분을 다듬어 주세요. CHI 磨掉毛刺



ENG Break off or cut out. UKR Відламайте або відріжте. DEU Abbrechen oder Abschneiden. FRA Coupez ou cassez. POL Odłam lub odetnij. SPA Rompa o corte. ITA Staccare o tagliare. RUS Отломайте или отрежьте. JAP 切ってください。KOR 잘라내 주세요. CHI 切断

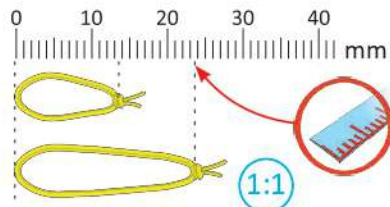

ENG Check size. UKR Перевірте розмір. DEU Prüfen Sie die Größe. FRA Vérifiez la dimension. POL Sprawdź rozmiar. SPA Compruebe el tamaño. ITA Controllare le dimensioni. RUS Проверьте размер. JAP サイズをチェックしてください。KOR 크기를 확인해 주세요. CHI 测量尺寸



ENG This is not a structural component; it is a tool for measurement and assembly. UKR Це не деталь конструкції, а допоміжний інструмент для складання або вимірювання відстаней. DEU Es ist kein Teil der Konstruktion, sondern ein Hilfselement für den Zusammenbau oder für das Messen der Abstände. FRA Cette pièce ne fait pas partie de la construction mais constitue un outil annexe pour l'assemblage ou la mesure des distances. POL To nie detal konstrukcji, a pomocnicze narzędzie dla montażu i wymiaru odległości. SPA No es una pieza de la construcción sino un instrumento auxiliar para montar o para medir distancias. ITA Non è un componente del modello, ma un'attrezzatura aggiuntiva per il montaggio o il rilievo delle quote. RUS Это не деталь конструкции, а вспомогательный инструмент для сборки или измерения расстояний. JAP この部品は完成時の部品ではなく、組み立てをサポートしたり測定する道具です。KOR 이 부품은 조립을 위한 부품이 아니고 조립을 돕거나 측정을 위한 도구입니다. CHI 这不是装配零部件，是一种测量及安装辅助工具。

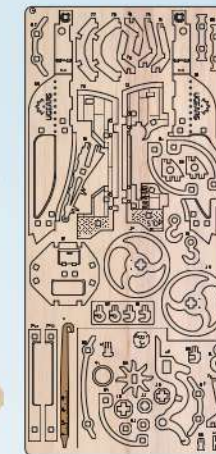
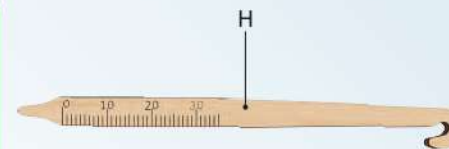
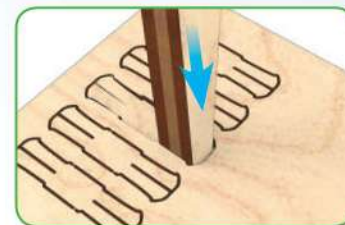

4

3

Mechanical models

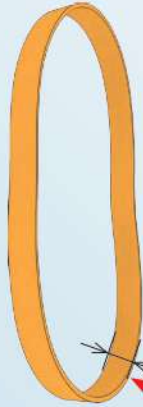
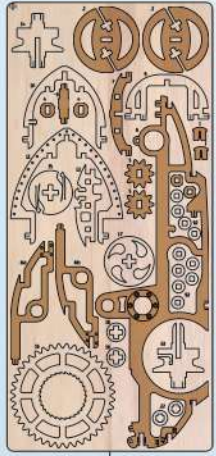

5mm/0.196"

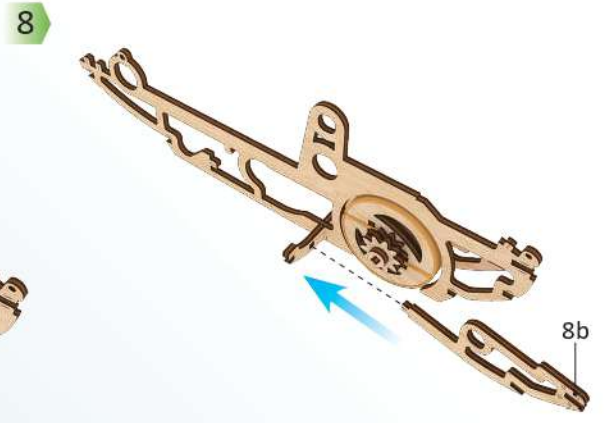
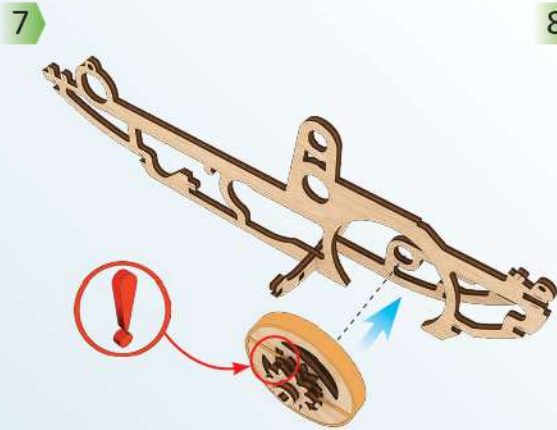
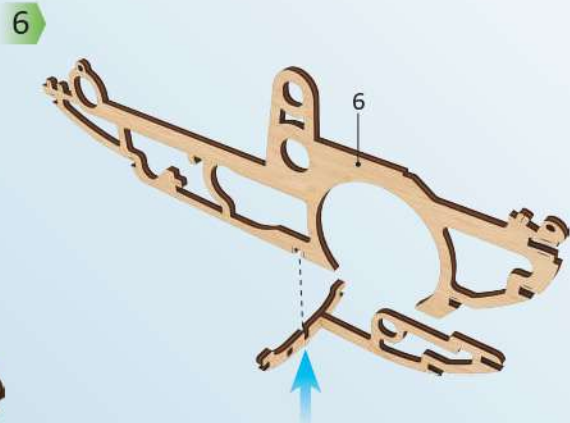
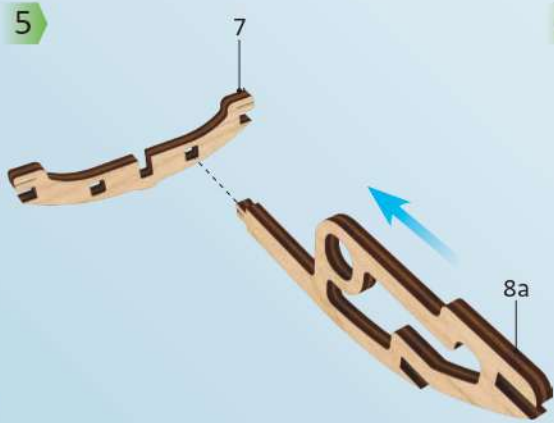
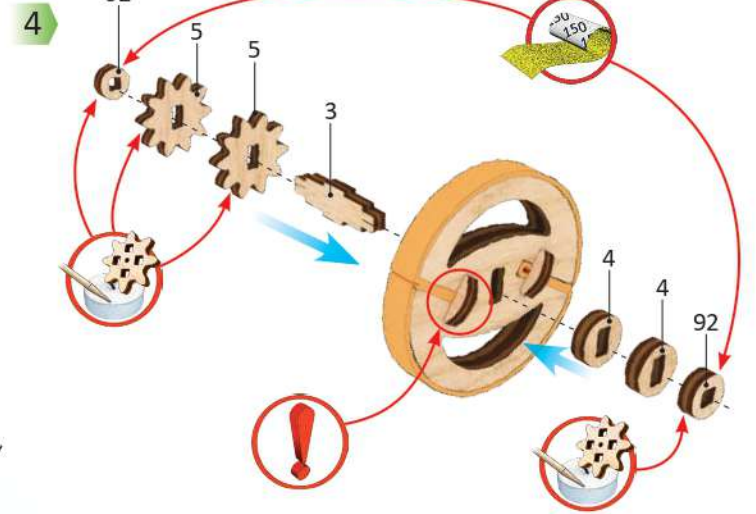
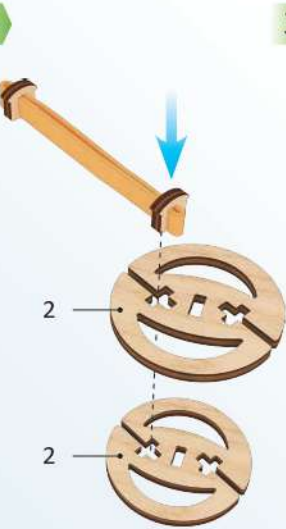
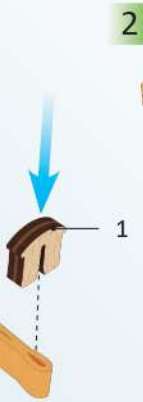
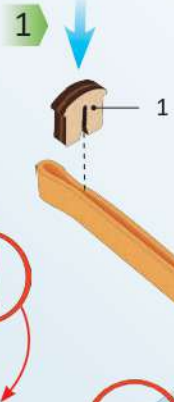

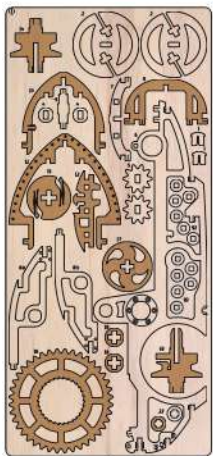

1

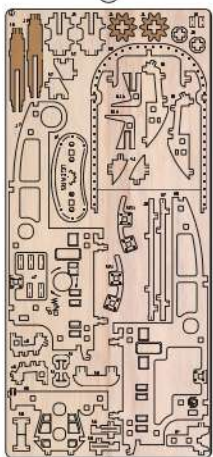

2

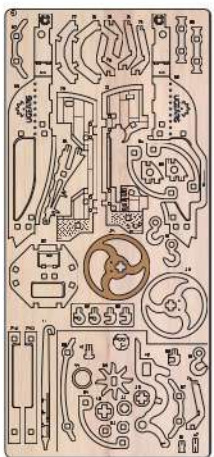

4

9

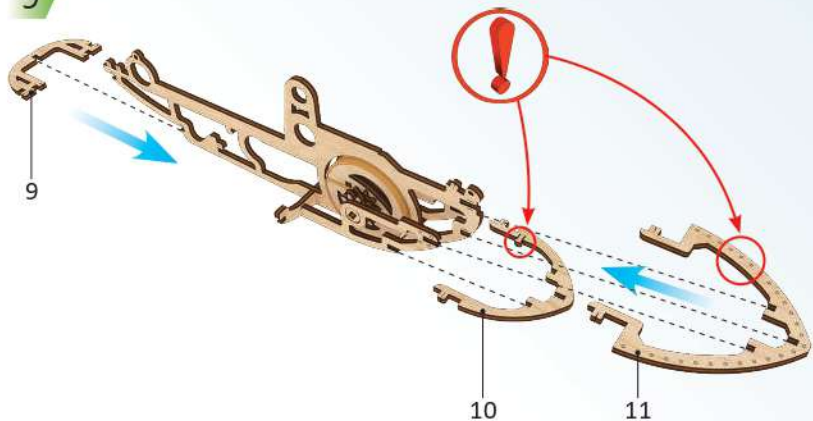

10

11

10

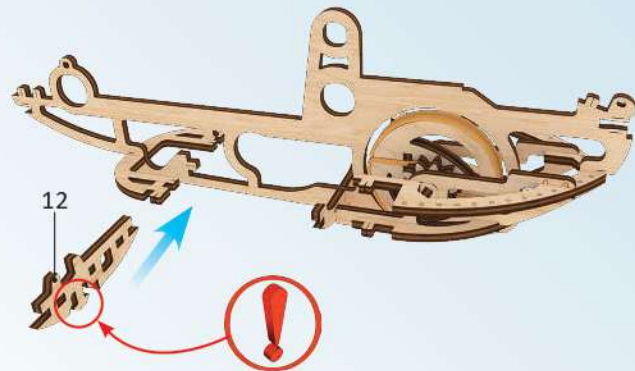

12

11

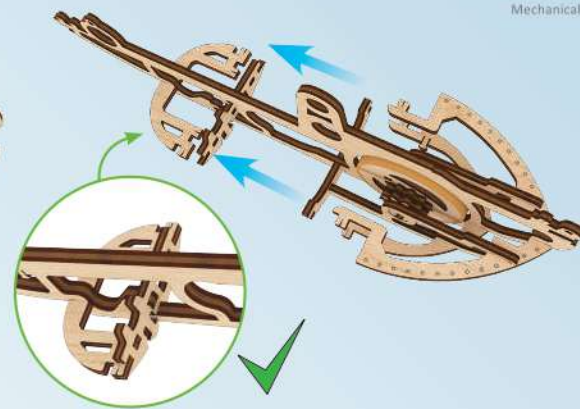

1

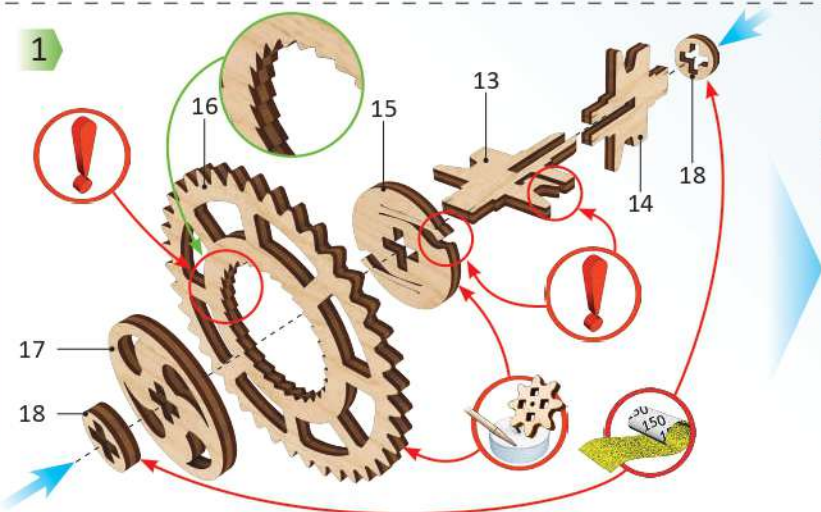

17

18

16

15

13

14

18

2

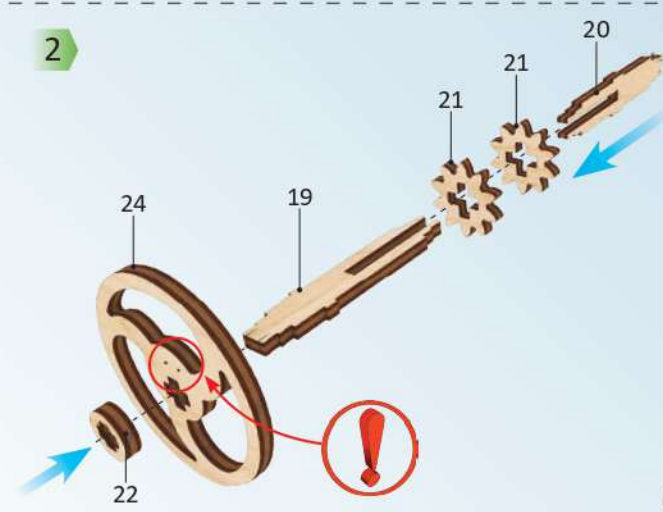

24

19

21

21

20

22

5

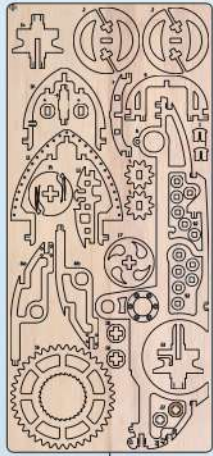

3

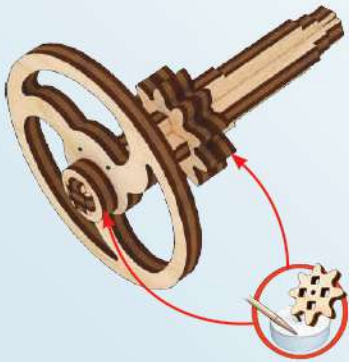

4

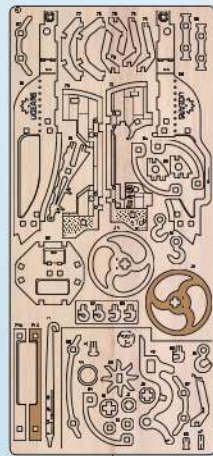
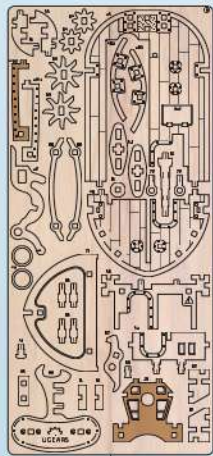
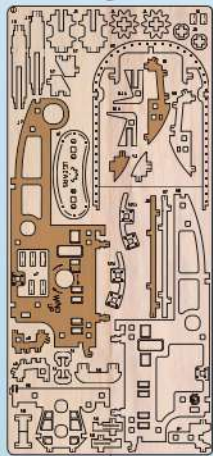
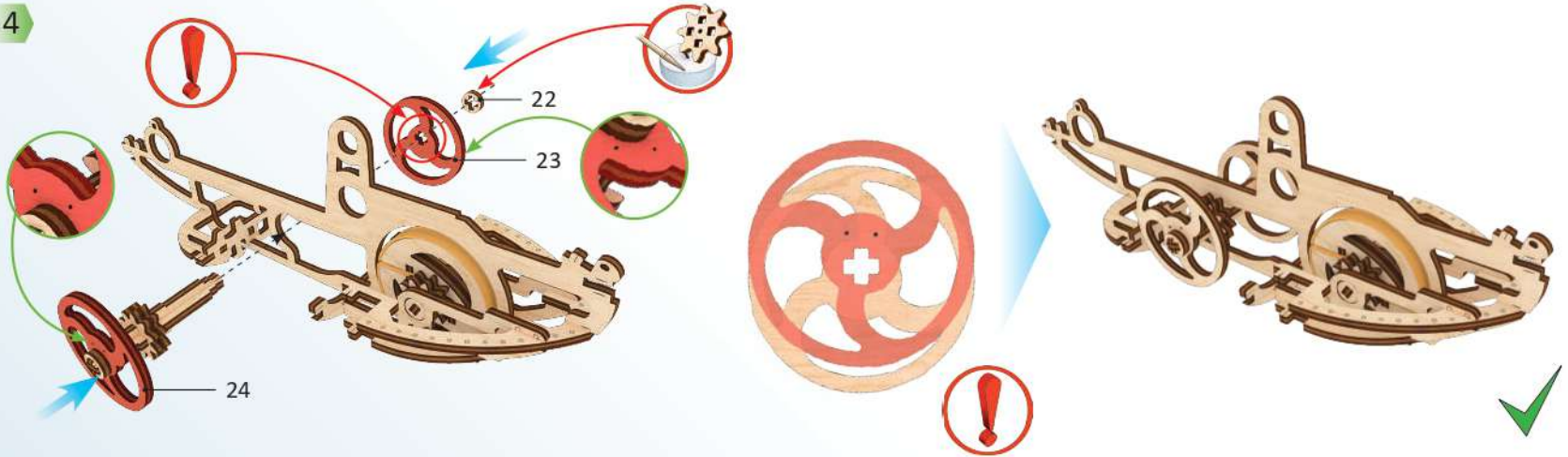

5

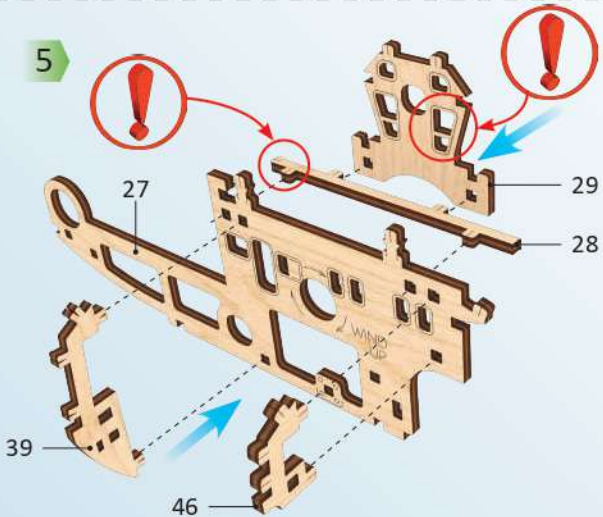

6

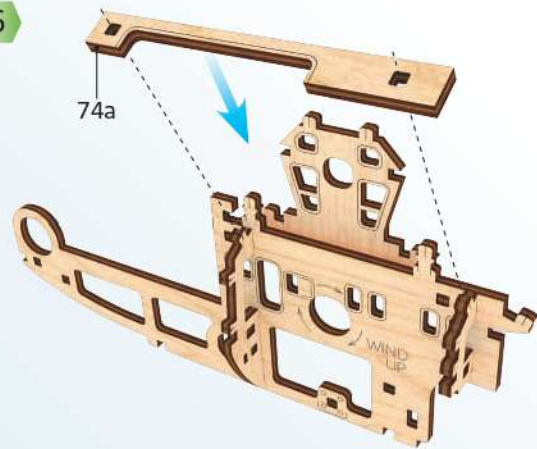

7

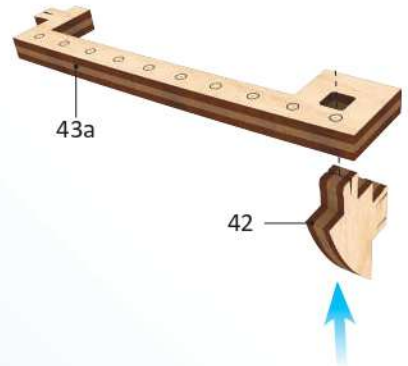

6

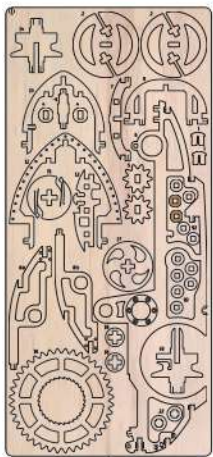

1

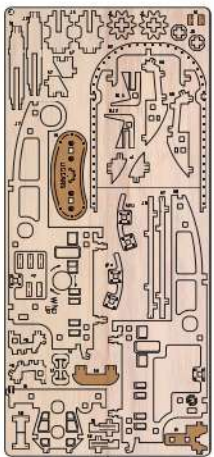

2

8

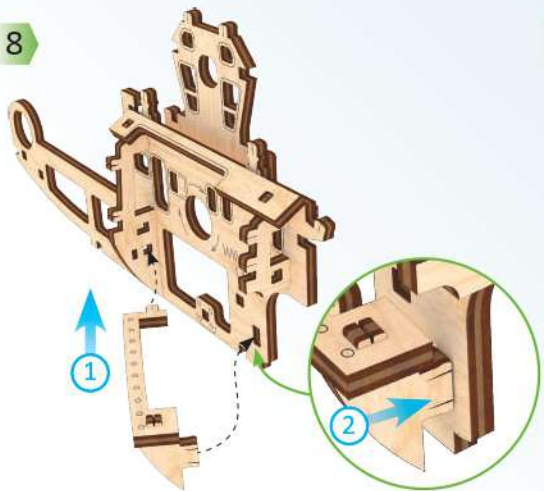

9

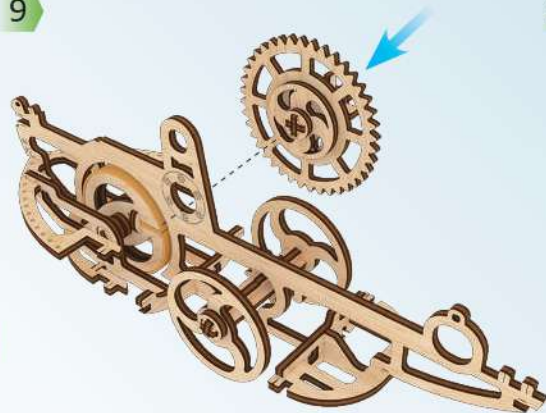

10

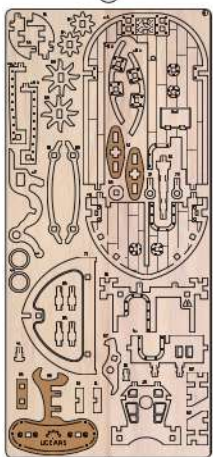
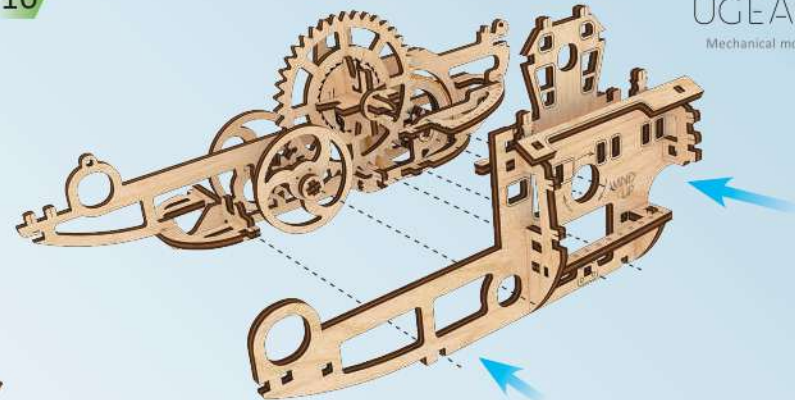

3

11

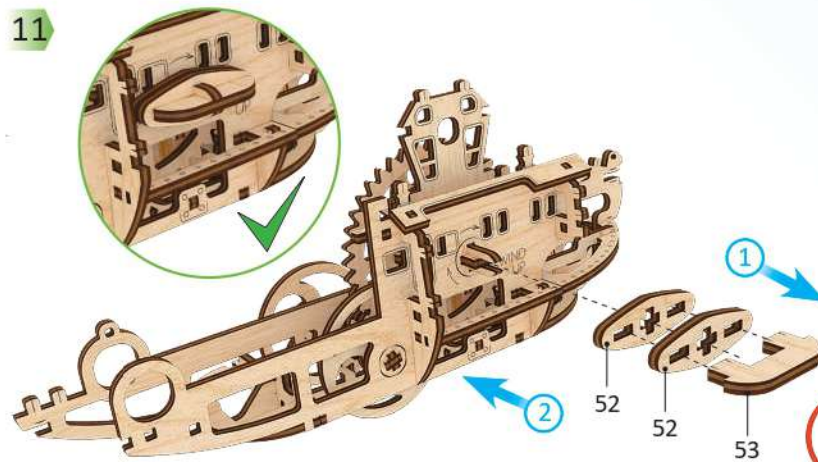

12

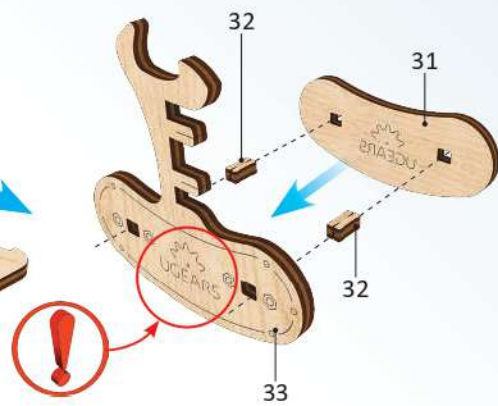

13

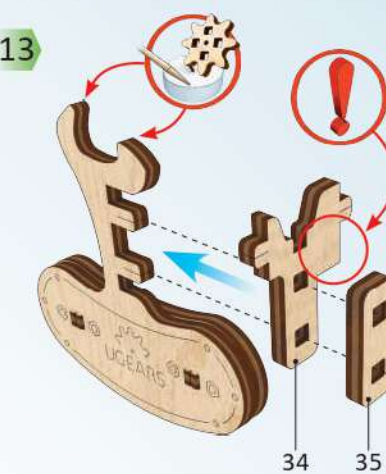

14

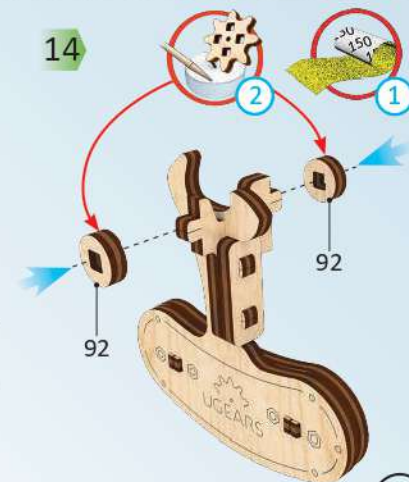

7

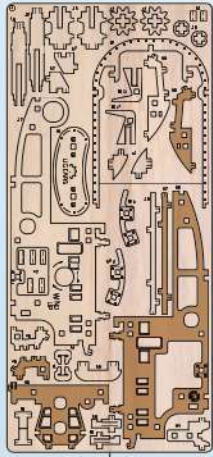

2

d=40mm/1.57"

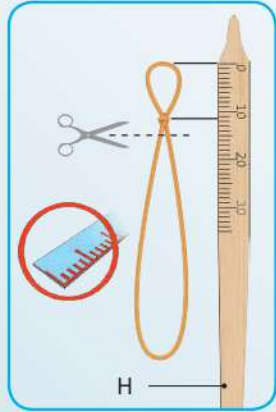

1

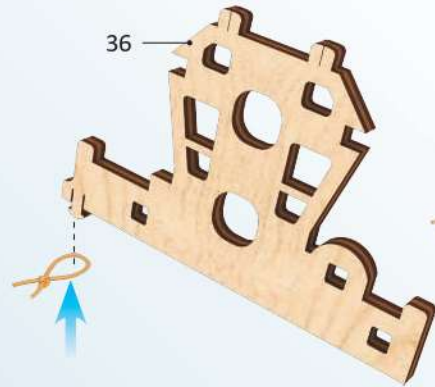

2

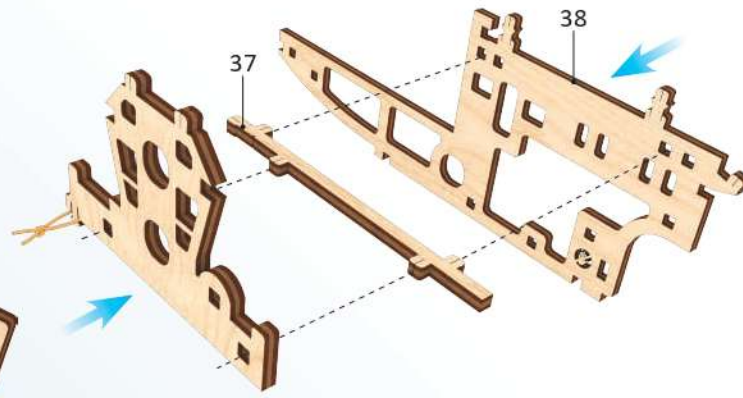

d=40mm/1.57"

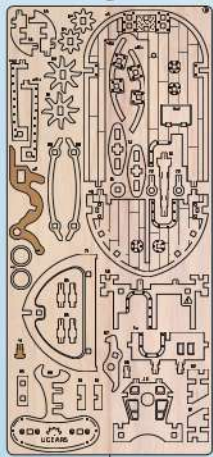
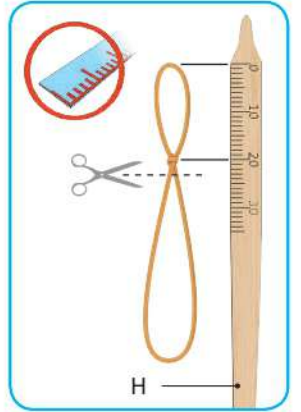

3

3

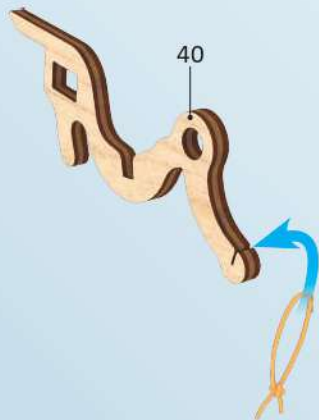

4

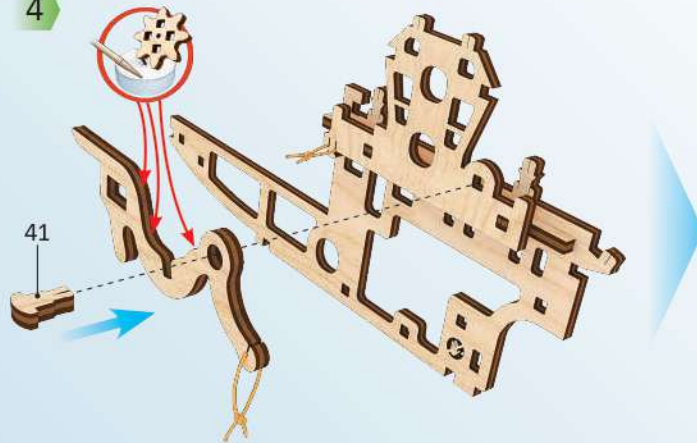

5

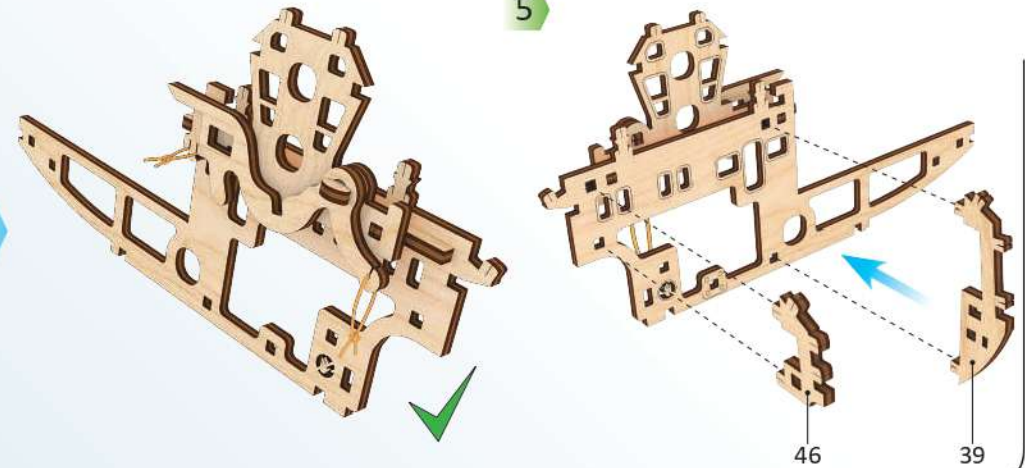

46

39

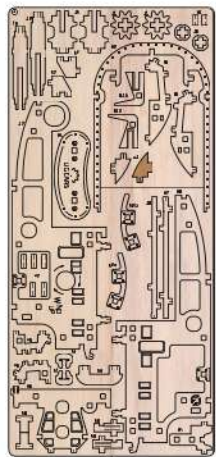

2

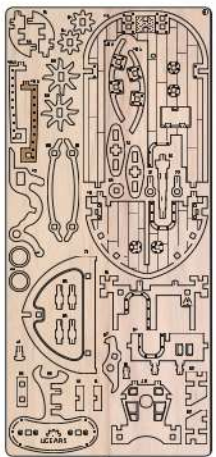

3

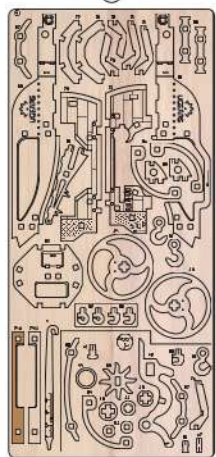
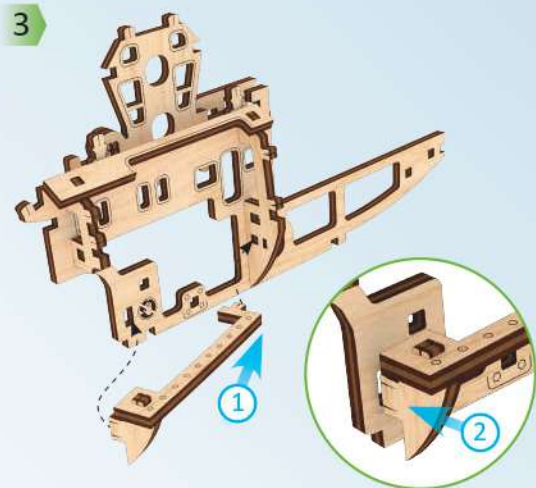
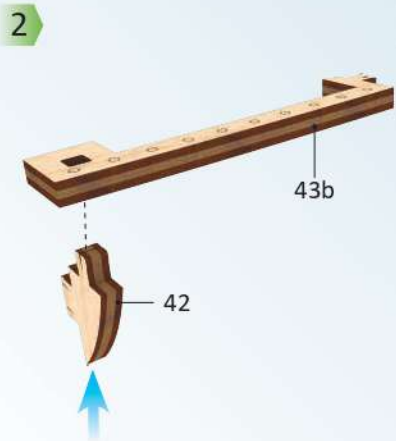
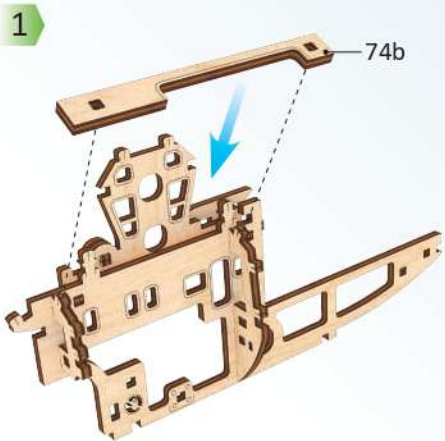

4

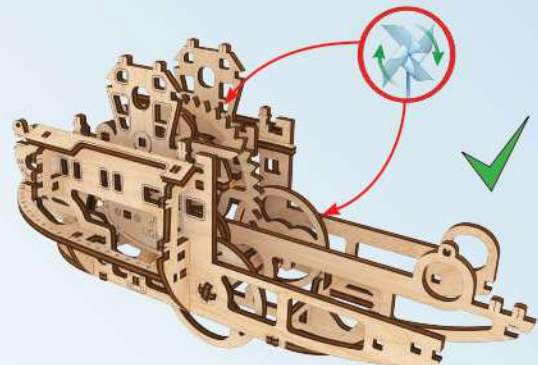
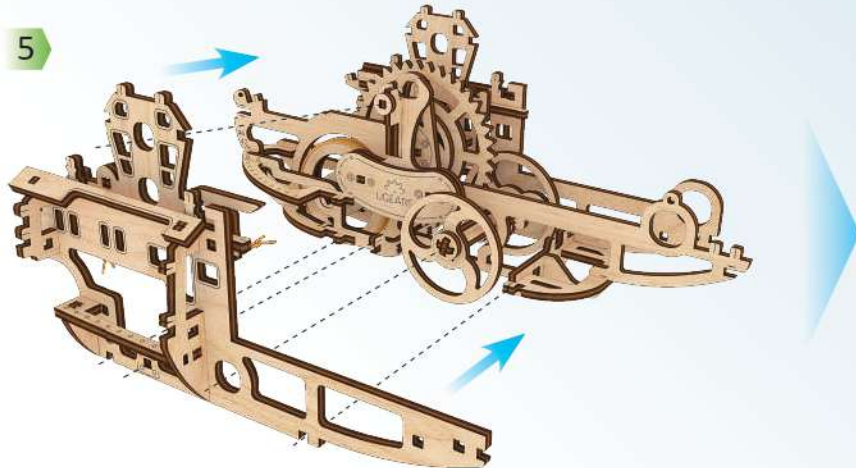
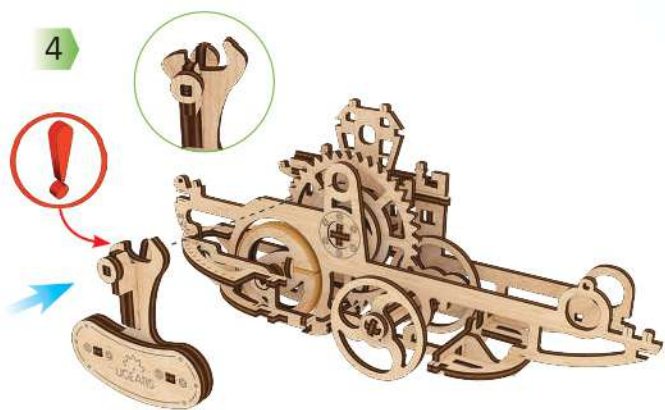

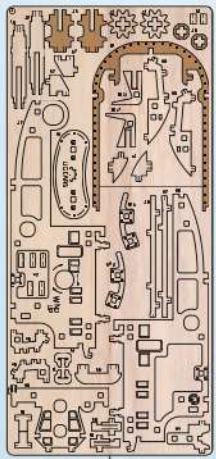

1

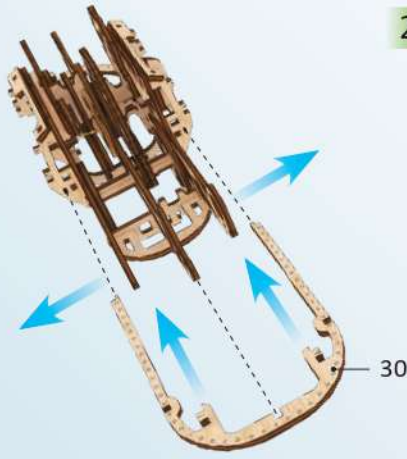

2

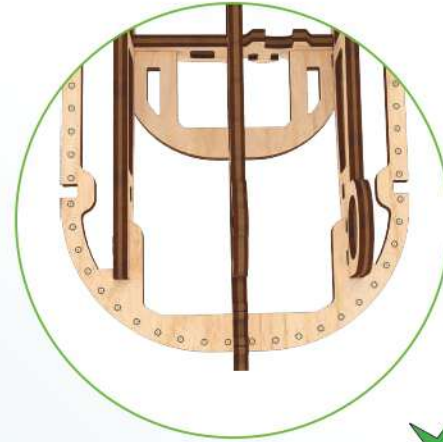
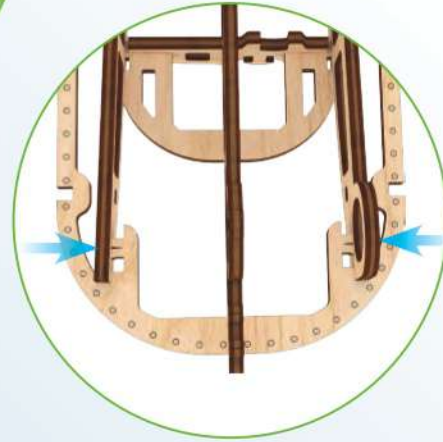

3

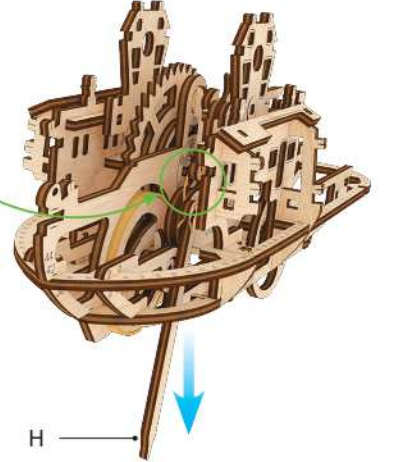

4

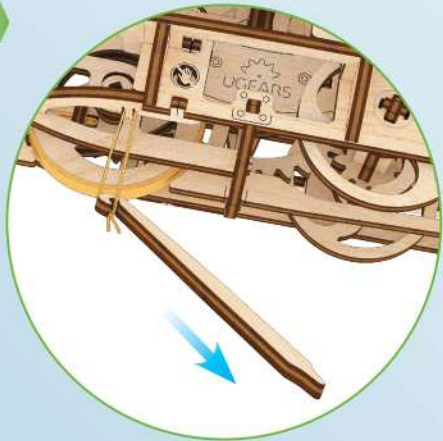

5

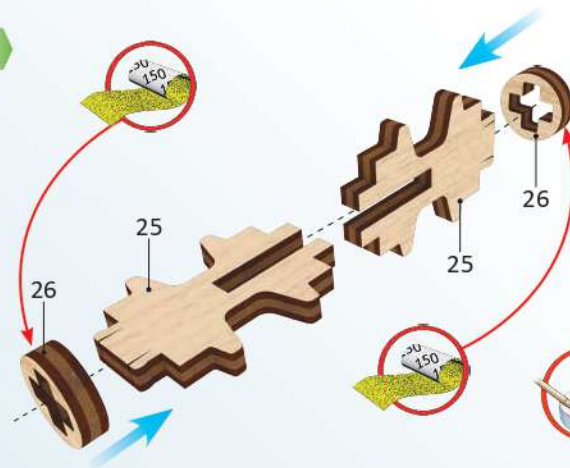

6



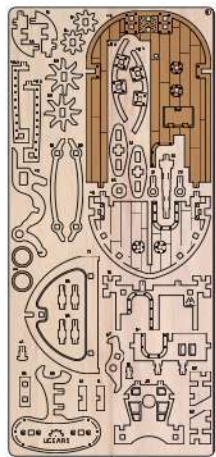

3

1



2

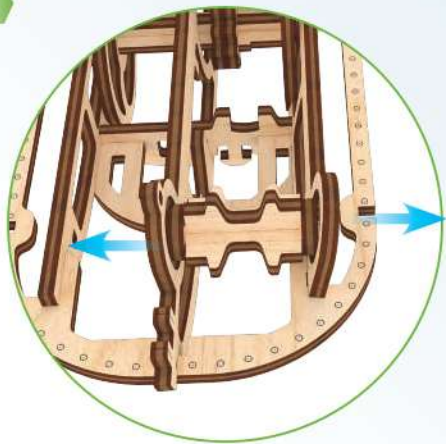

3

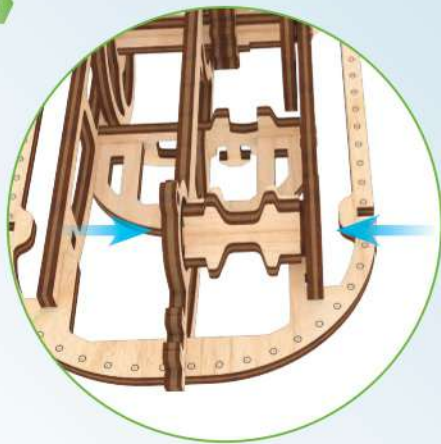

4

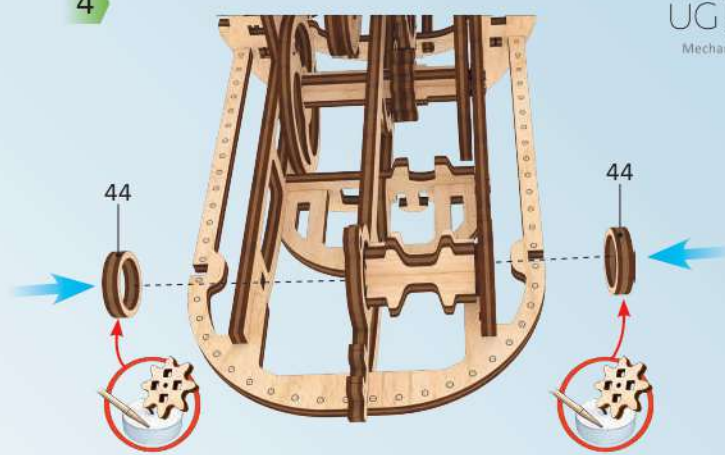

5

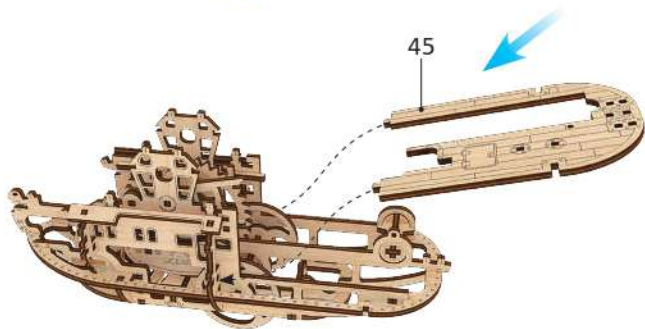

6



7

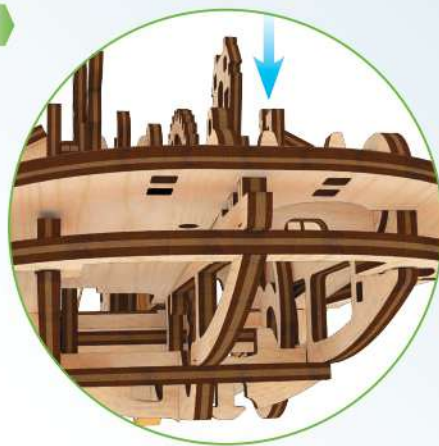

Mechanical models

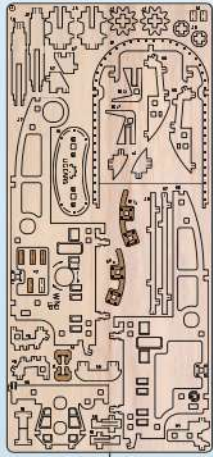

2

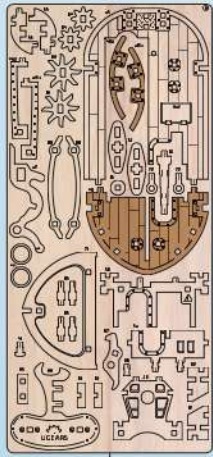
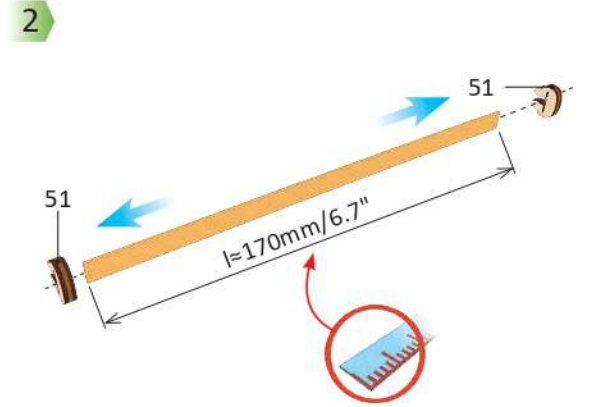
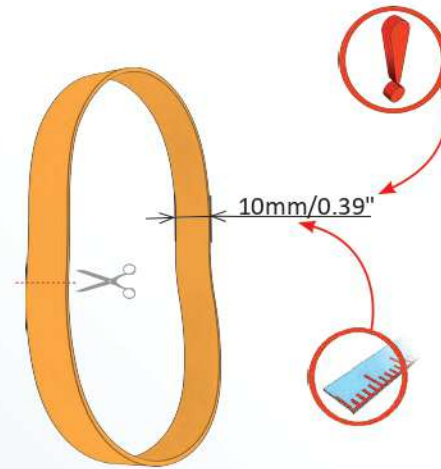
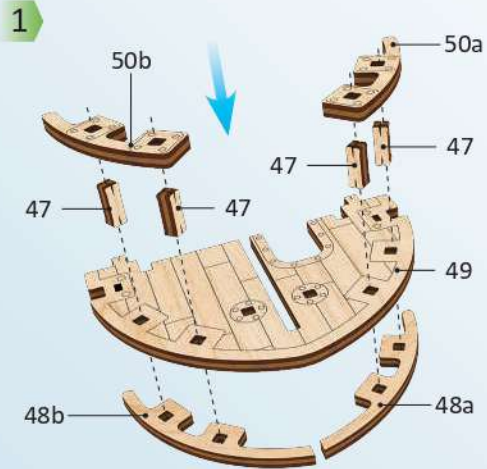

3

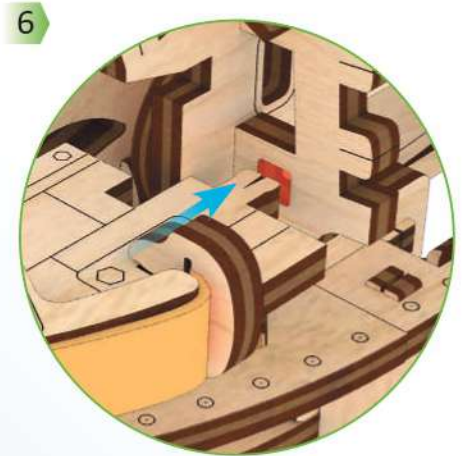
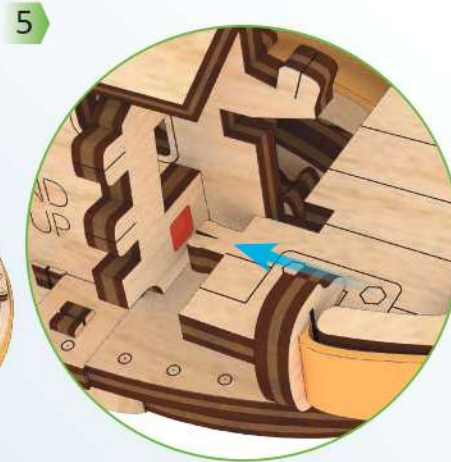
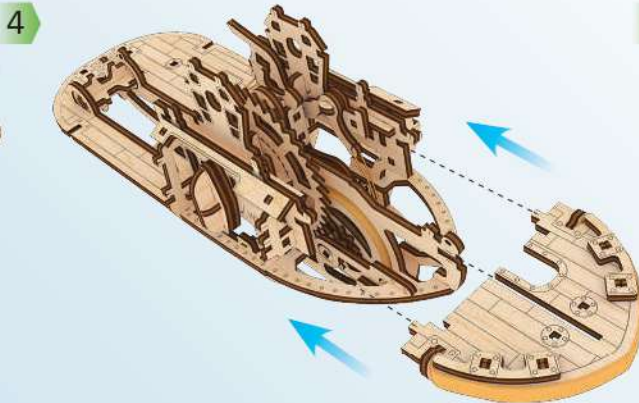

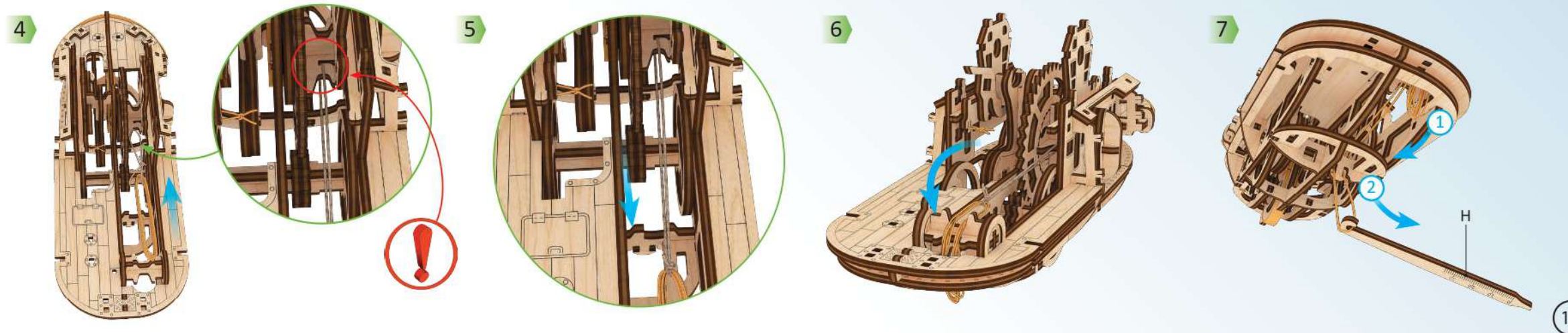
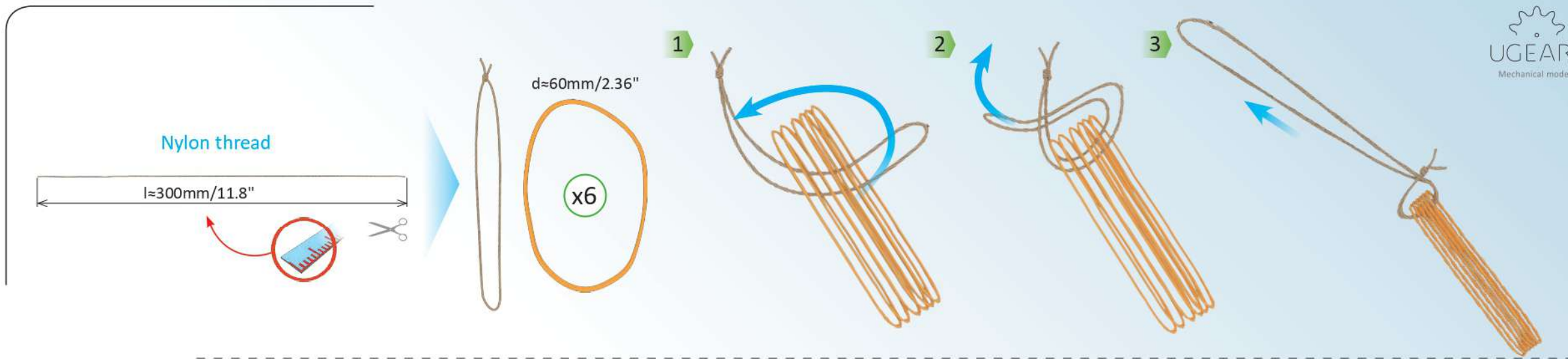

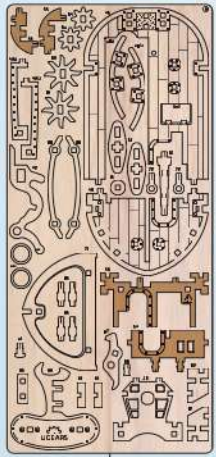

8

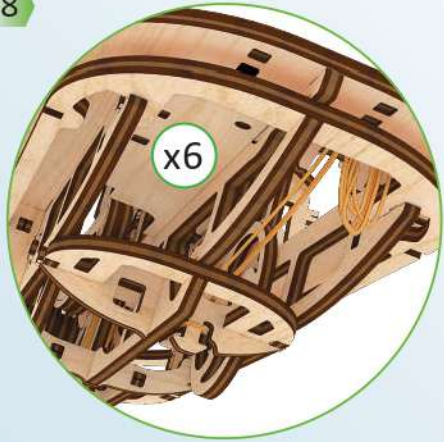

9



1

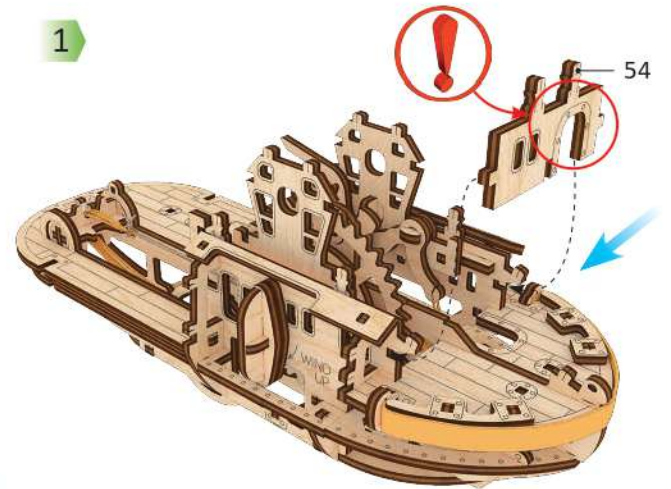

2

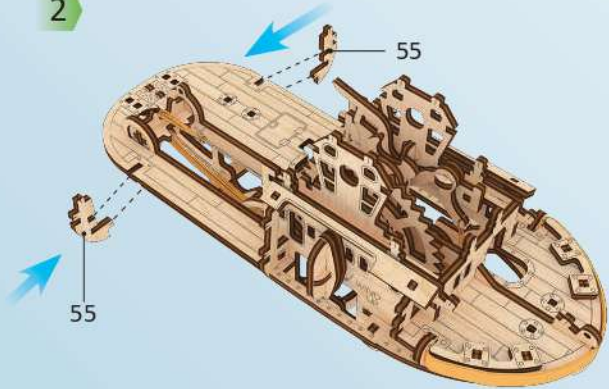

3

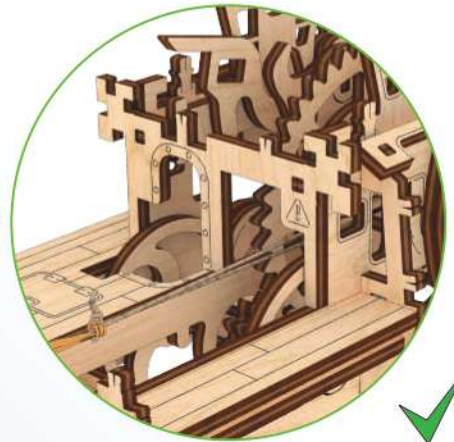
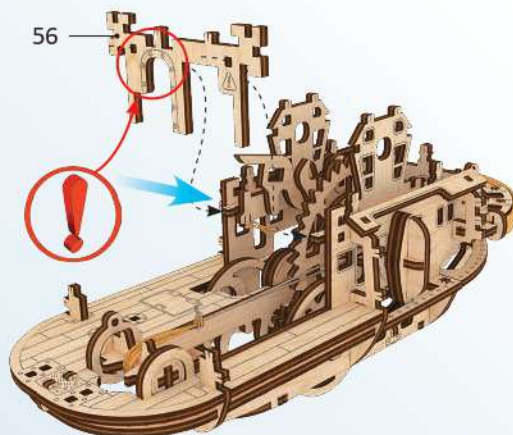

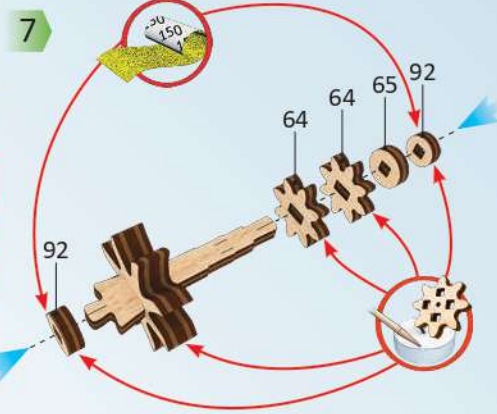
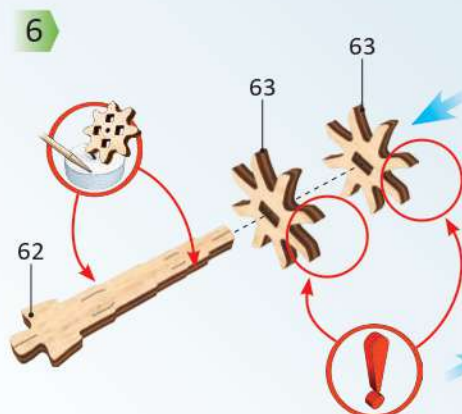
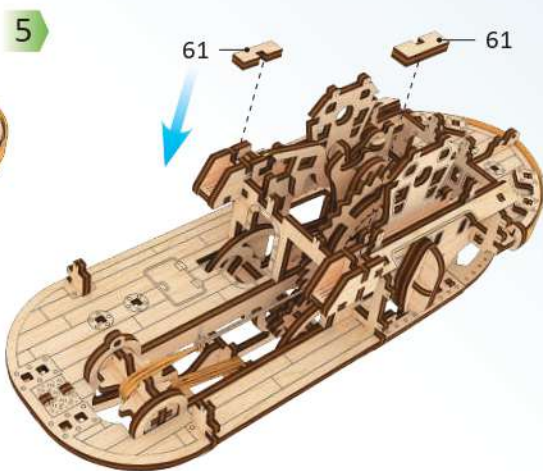
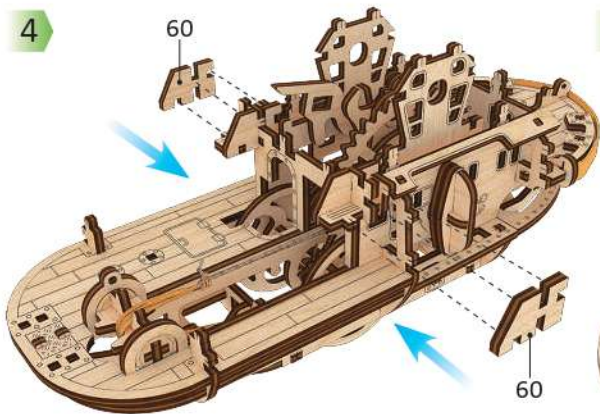
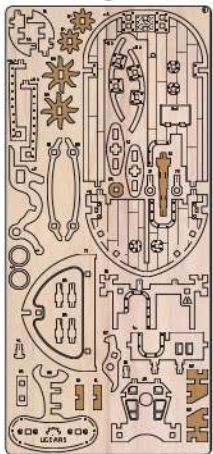
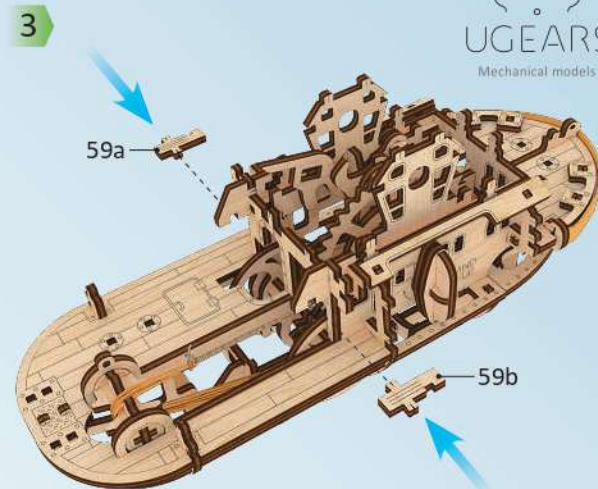
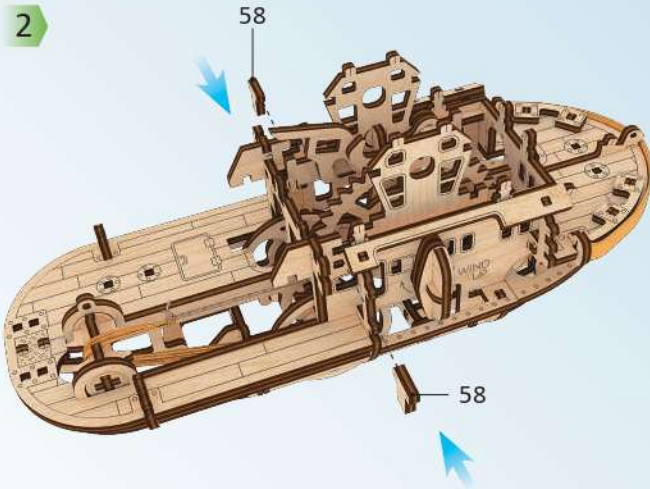
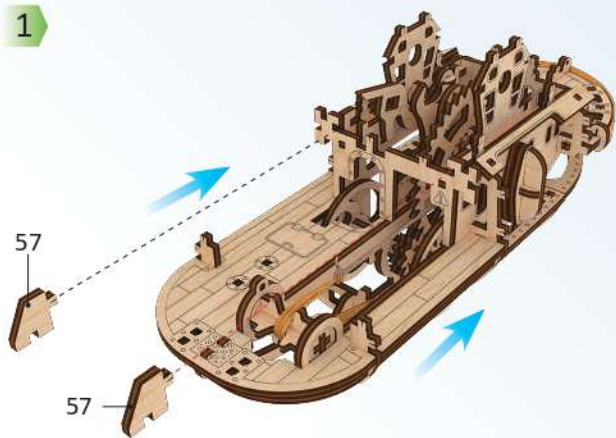
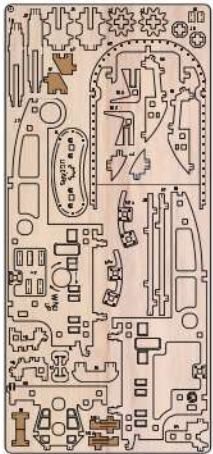
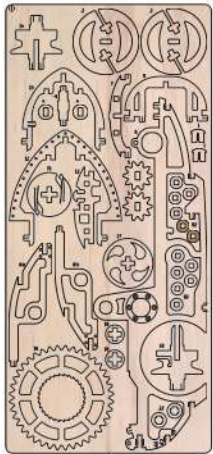

1

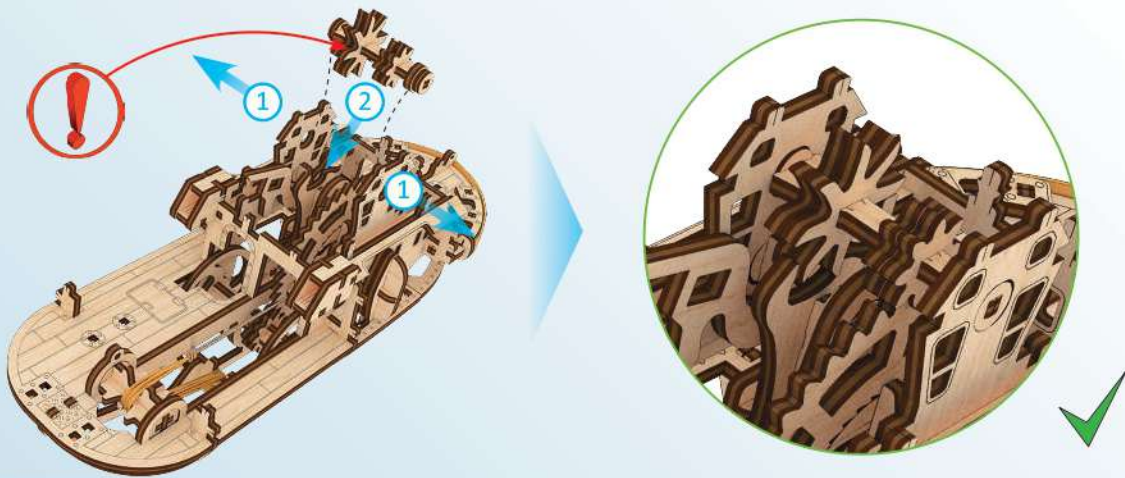

2

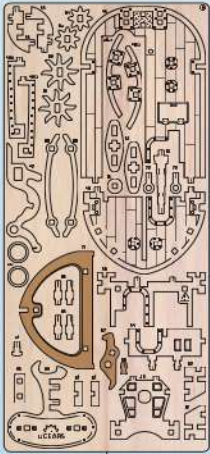
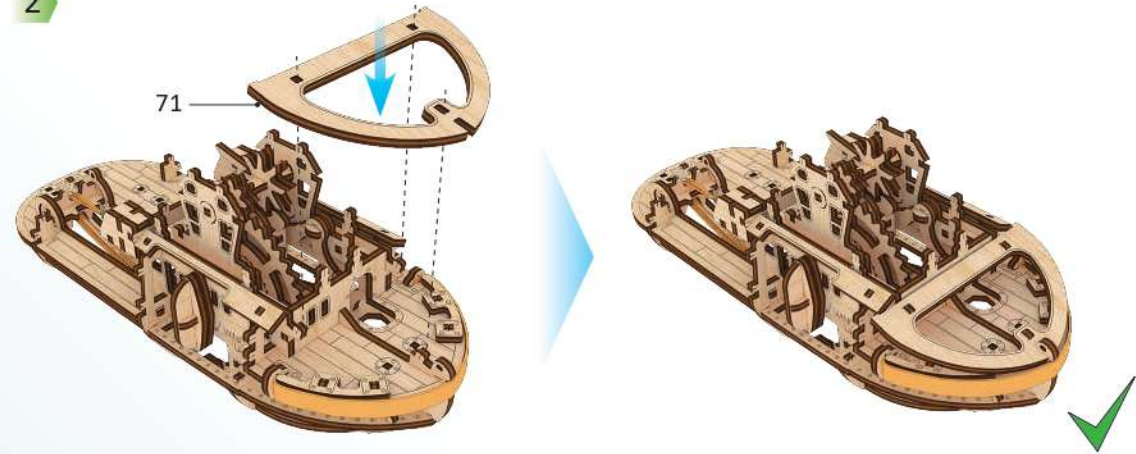

3

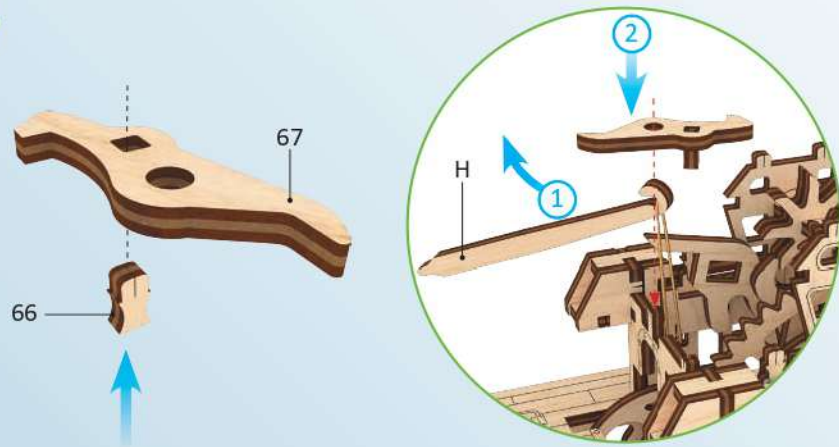

4

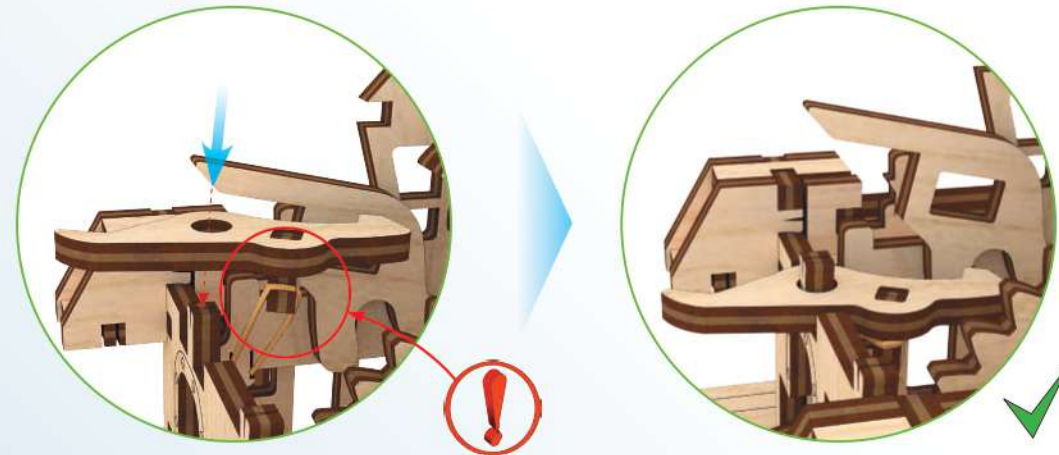

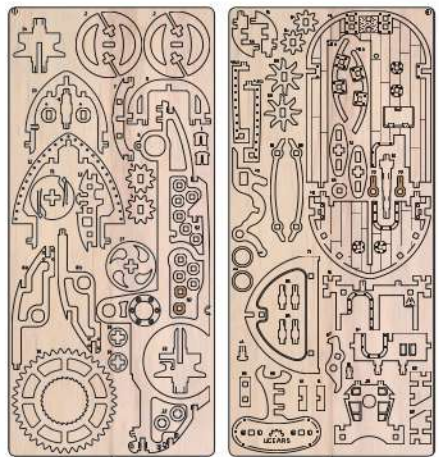

1

3

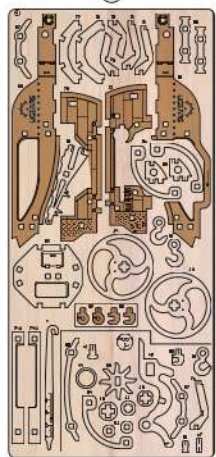
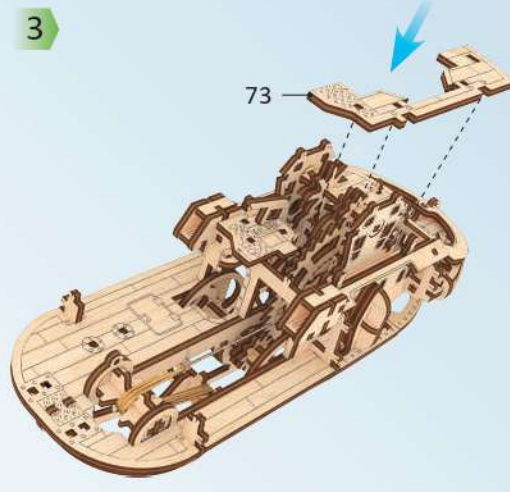
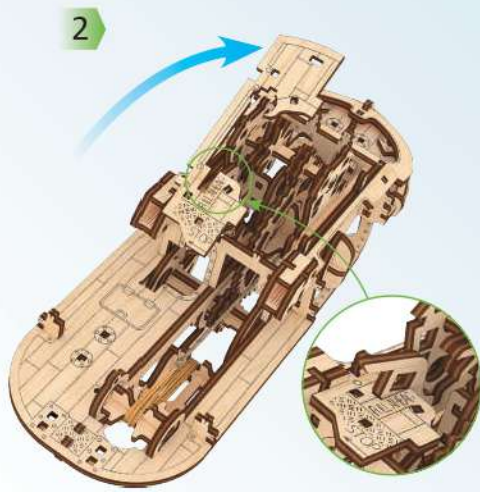
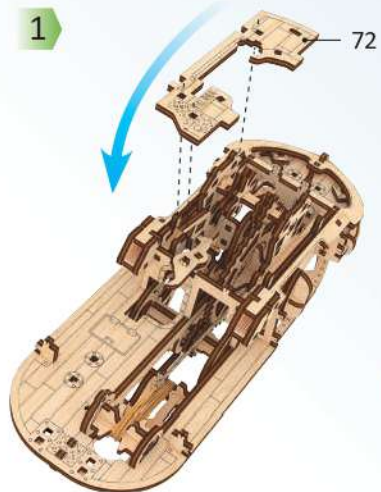

4

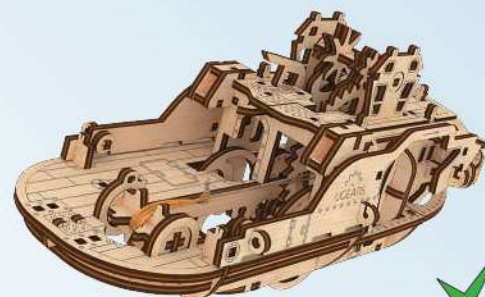
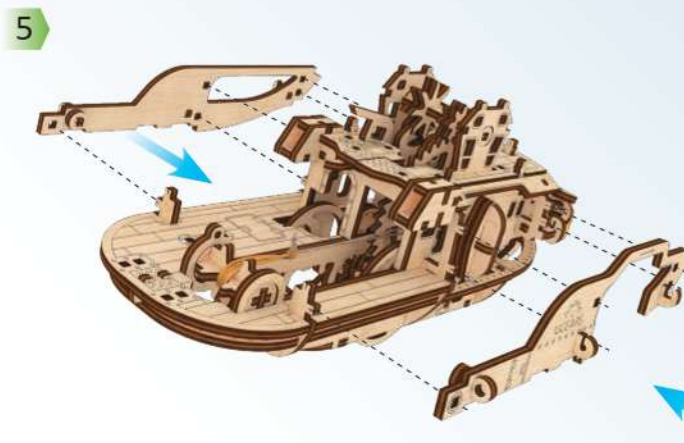
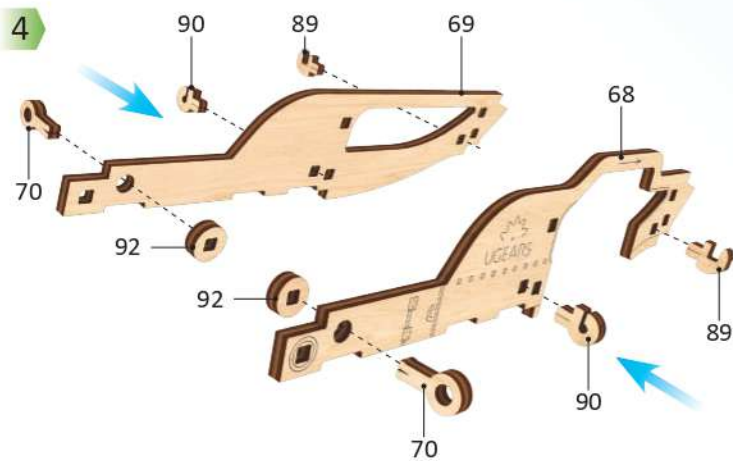

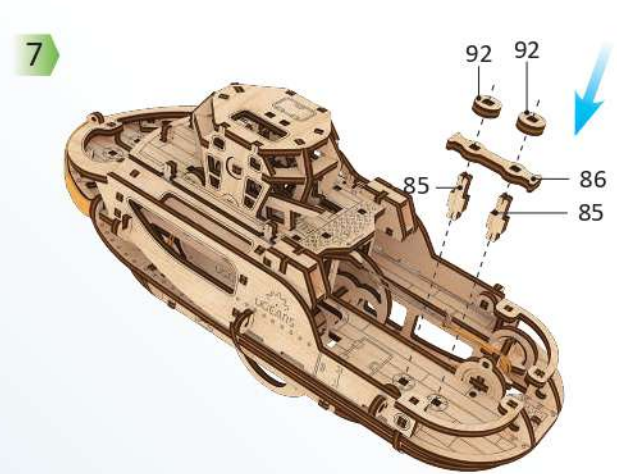
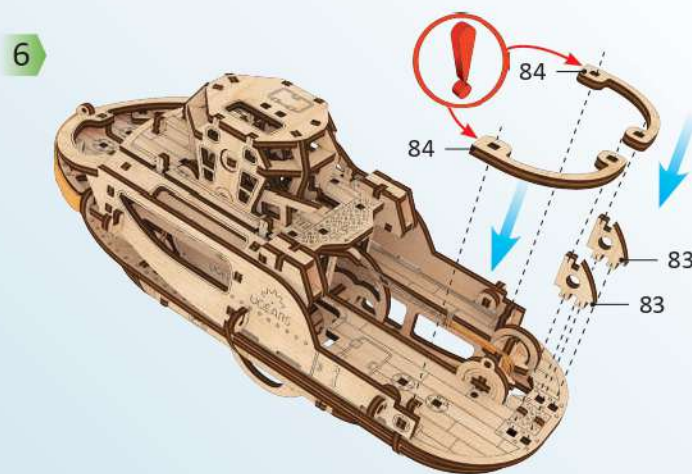
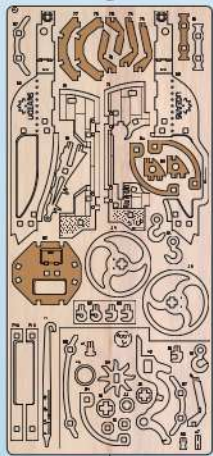
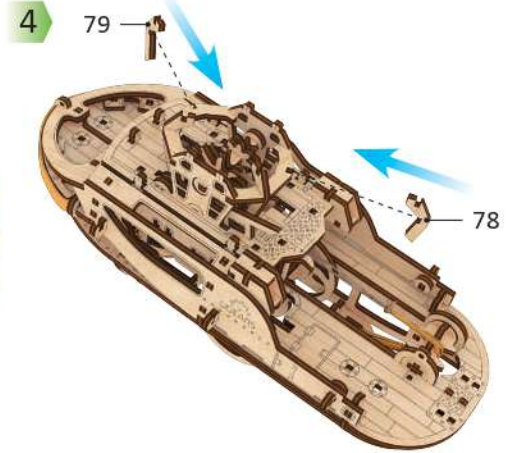
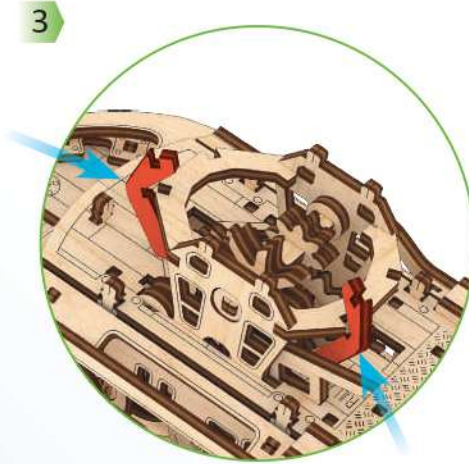
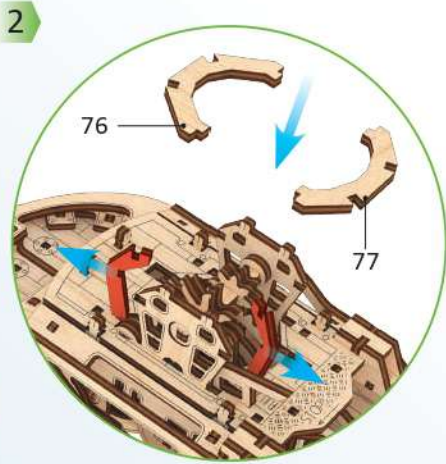
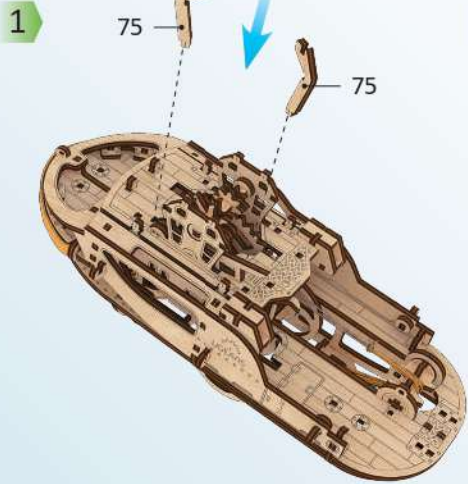
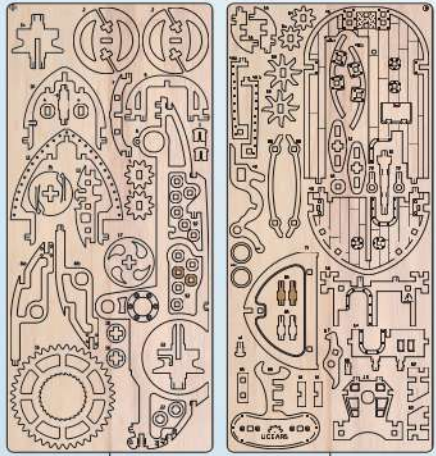

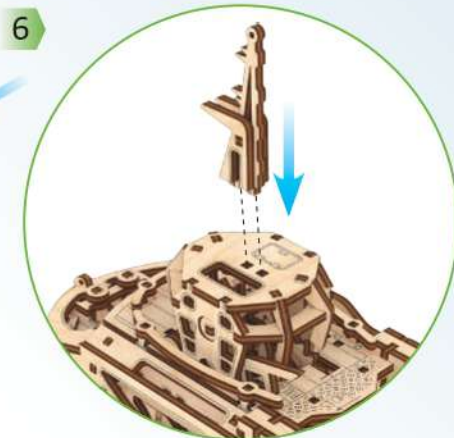
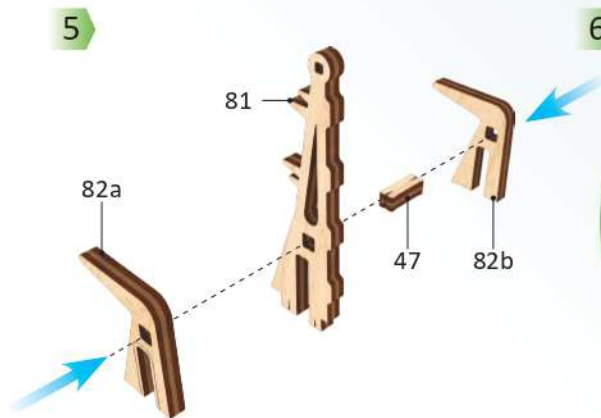
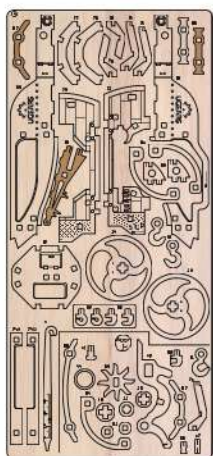
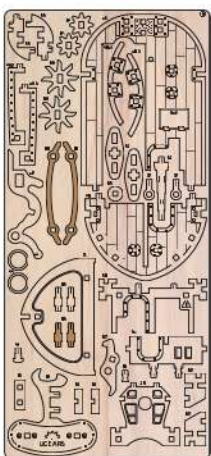
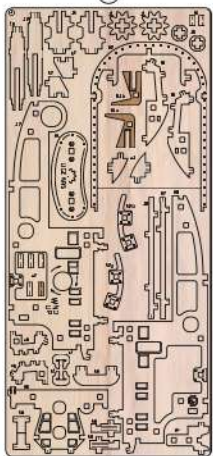
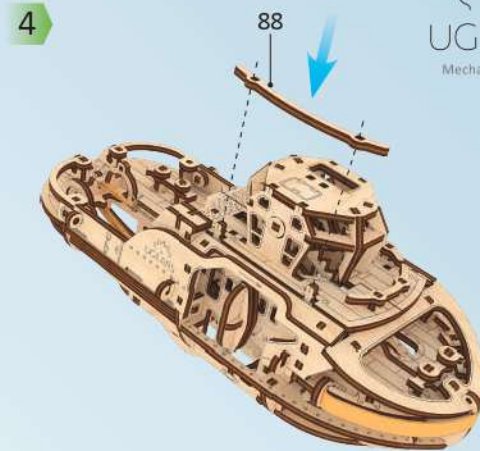
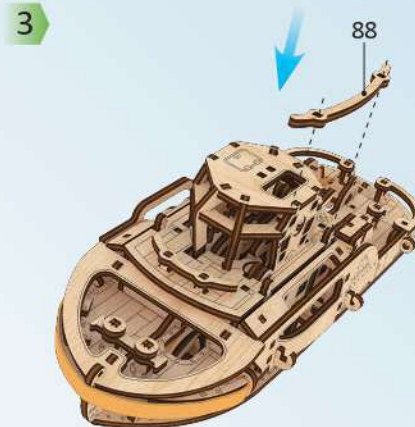
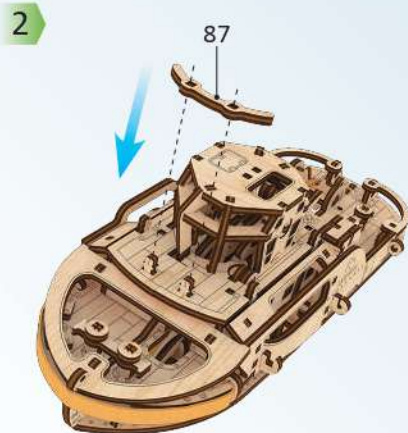
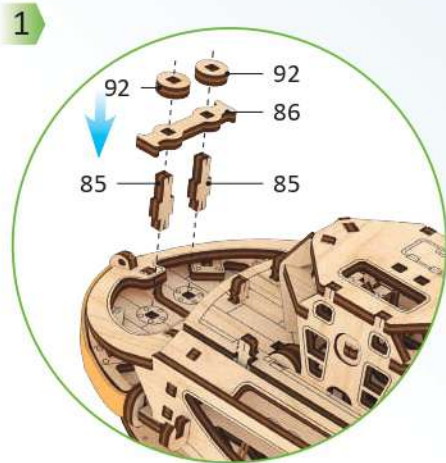
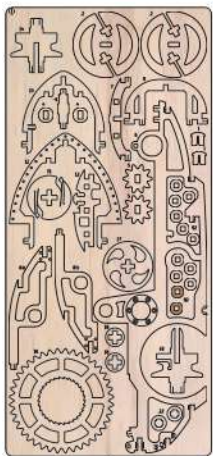

1

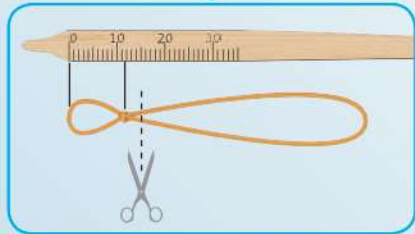

2

Nylon thread

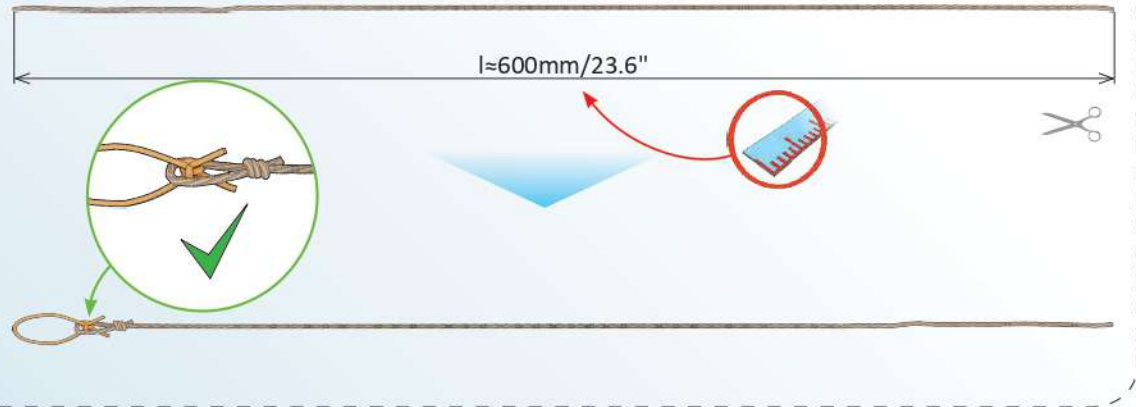

1

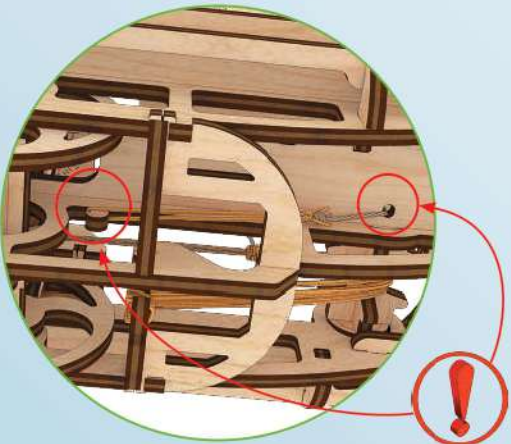
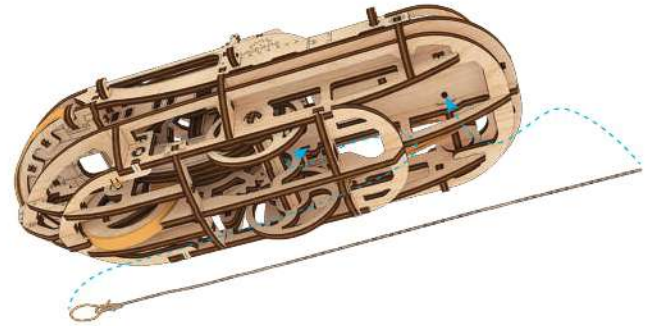

2

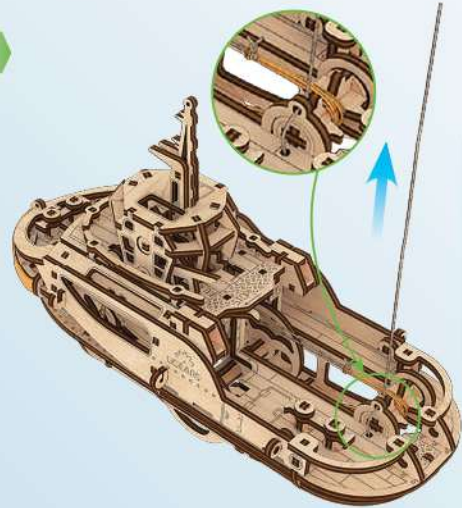

3

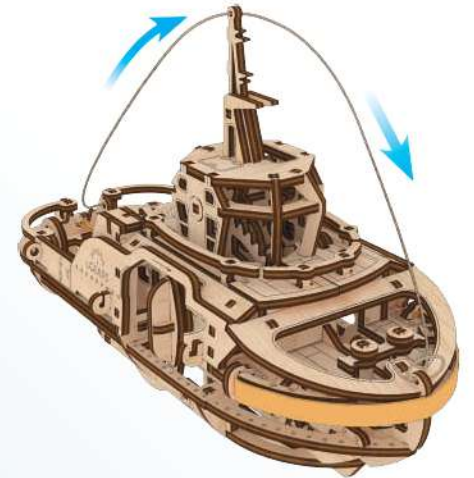
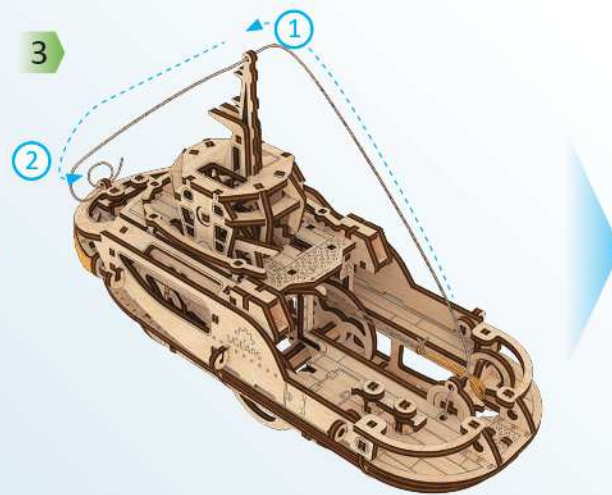

4

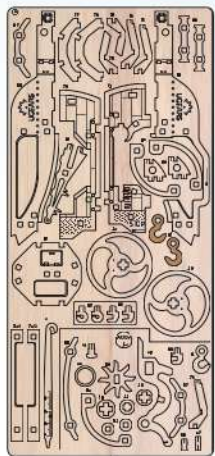
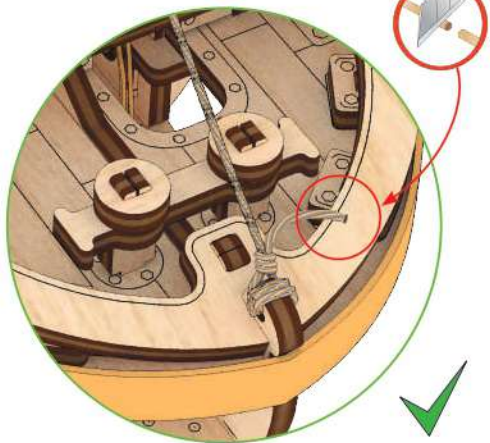
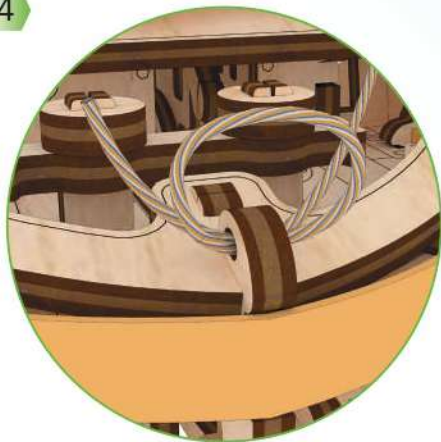

1

Linen thread

$l \approx 250\text{mm} / 9.84''$

91

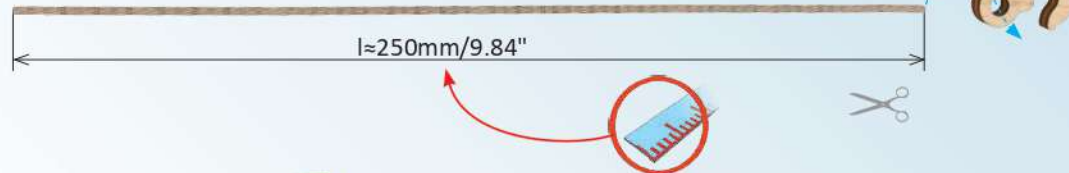

2

x2



3

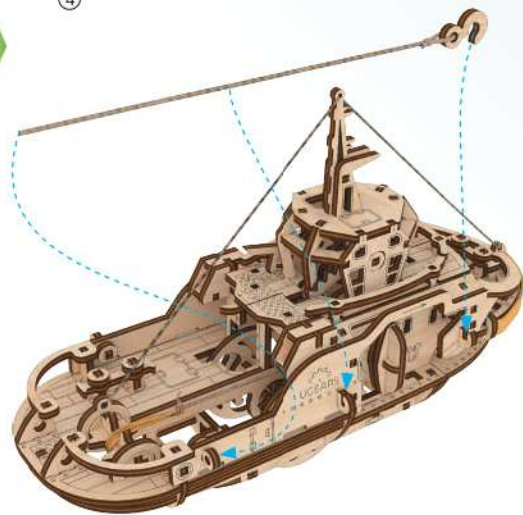

4

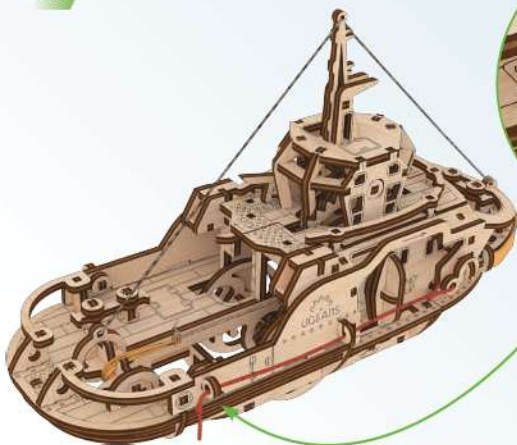

5

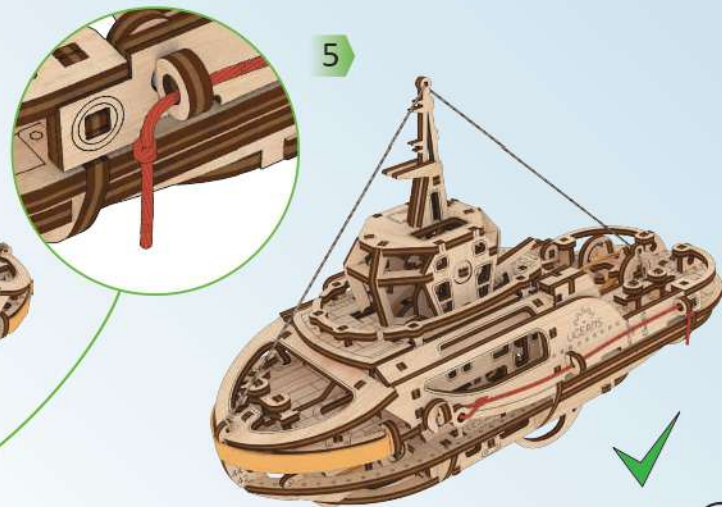

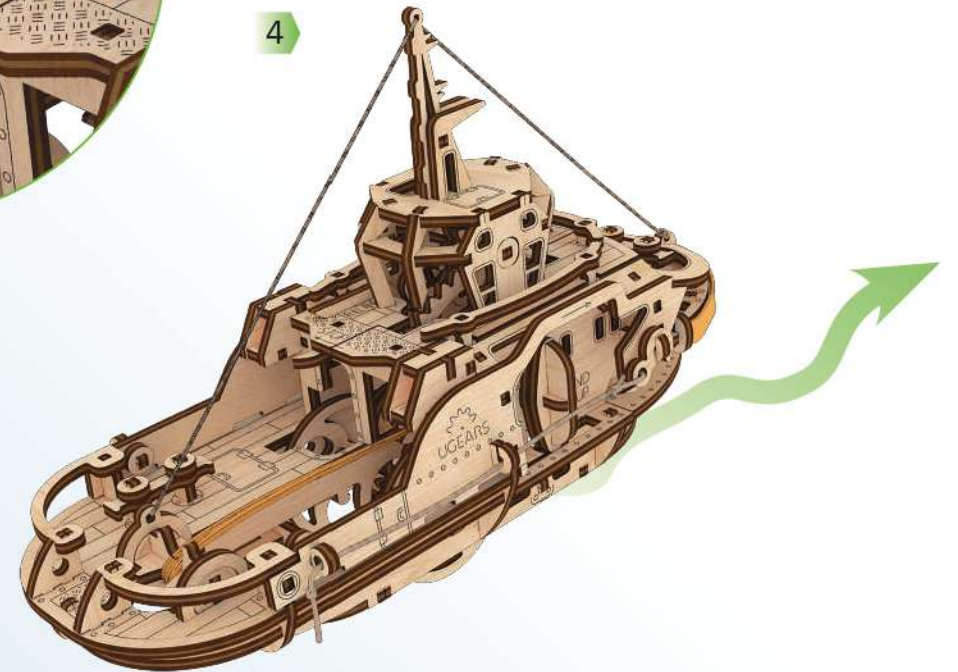
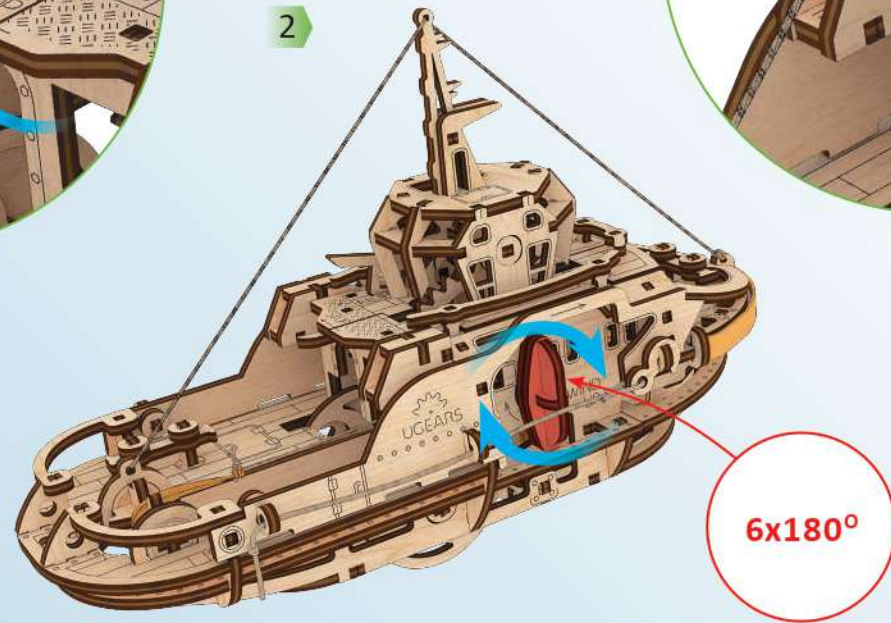
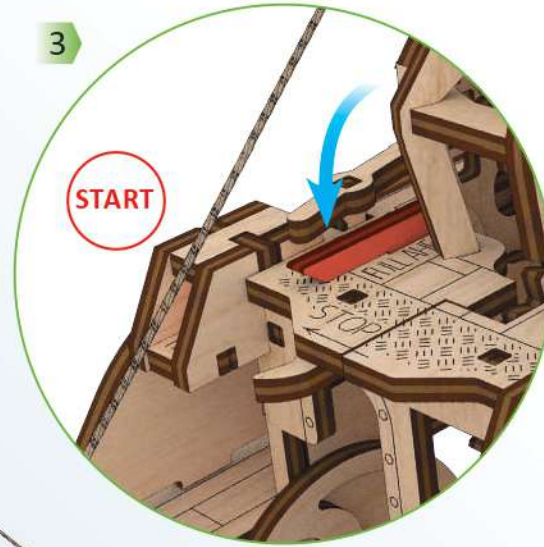
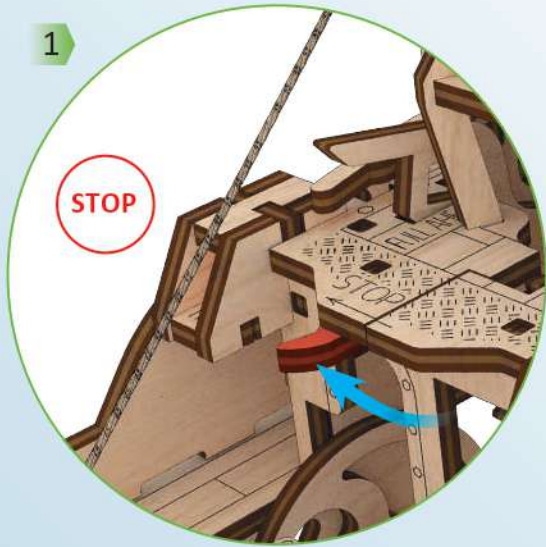

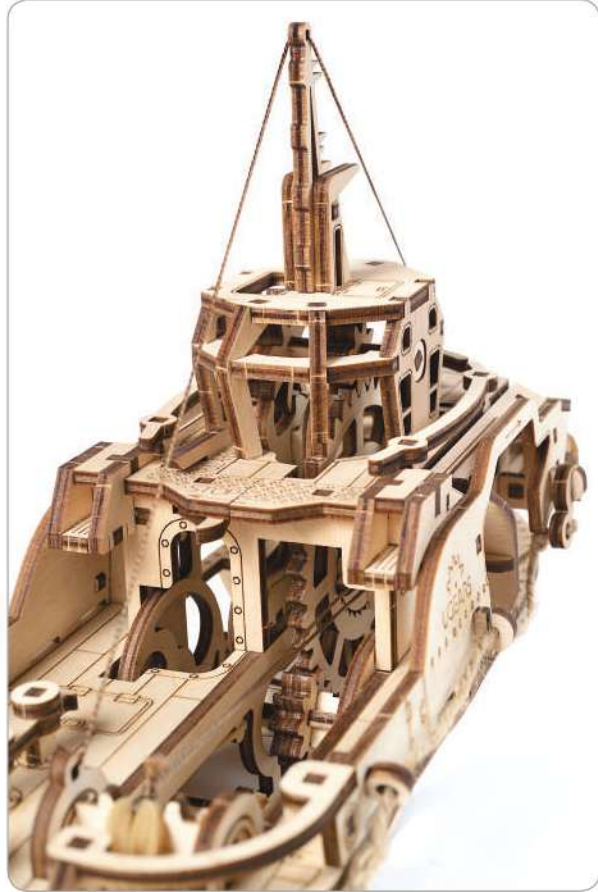



ENG Thanks for following along on this journey with us. UKR Дякуємо, що ви пройшли цей шлях з нами. DEU Vielen Dank, dass Sie diesen Weg mit uns gegangen sind. FRA Merci denous avoir accompagnés tout au long de ces étapes. POL Dziękujemy, że razem z nami pokonałeś tę drogę! SPA Gracias por haber recorrido el camino con nosotros. ITA Grazie per aver fatto uesto percorso con noi. RUS Спасибо, что вы прошли этот путь с нами. JAP UGEARSをご利用いただきありがとうございます。 KOR UGEARS 와 함께해 주셔서 감사합니다. CHI 感谢您参与有趣的模型配装过程。

ugearsmodels.com