

**Kundenservice/Importeur | Customer service / importer |  
Service après-vente / importateur | Klantenservice / importeur:**

DS Produkte GmbH  
Am Heisterbusch 1  
19258 Gallin  
Deutschland (Germany | Allemagne | Duitsland)  
Tel.: +49 38851 314650

(0 – 30 Ct./Min. in das dt. Festnetz. Kosten variieren je nach Anbieter.)  
(Calls to German landlines are subject to charges. The cost varies depending on the service provider.)  
(Prix d'un appel vers le réseau fixe allemand. Coût variable selon le prestataire.)  
(Niet gratis voor Duitse vaste lijnen. Kosten variëren per aanbieder.)



**06900**

**DE** **Gebrauchsanleitung**  
ab Seite 3

**EN** **Instruction manual**  
starting on page 13

**FR** **Mode d'emploi**  
à partir de la page 23

**NL** **Handleiding**  
vanaf pagina 34

**DE**

**HINWEIS!**

Auf der Ausklappseite dieser Gebrauchsanleitung finden Sie eine Übersicht des SUP-Boards sowie aller Zubehörteile sowie Abbildungen zur Handhabung des Artikels. Diese Seite beim Lesen der Gebrauchsanleitung immer geöffnet lassen.

**EN**

**NOTICE!**

On the fold-out page of this manual you will find an overview of the SUP board as well as all accessories and illustrations for handling the article. Always leave this page open when reading this manual.

**FR**

**AVIS !**

Sur la page rabattable du présent mode d'emploi, vous trouverez un aperçu du SUP Board et de tous ses accessoires ainsi que les illustrations se rapportant au maniement de l'article. Veuillez laisser cette page toujours ouverte lorsque vous consultez le mode d'emploi.

**NL**

**LET OP!**

Op de uitklapzijde van deze gebruikershandleiding vindt u een overzicht van het SUP board alsook van alle toebehoren en afbeeldingen voor gebruik van het artikel. Laat deze pagina tijdens het lezen van de gebruikershandleiding altijd geopend.

Z 06900 M DS V1 0818

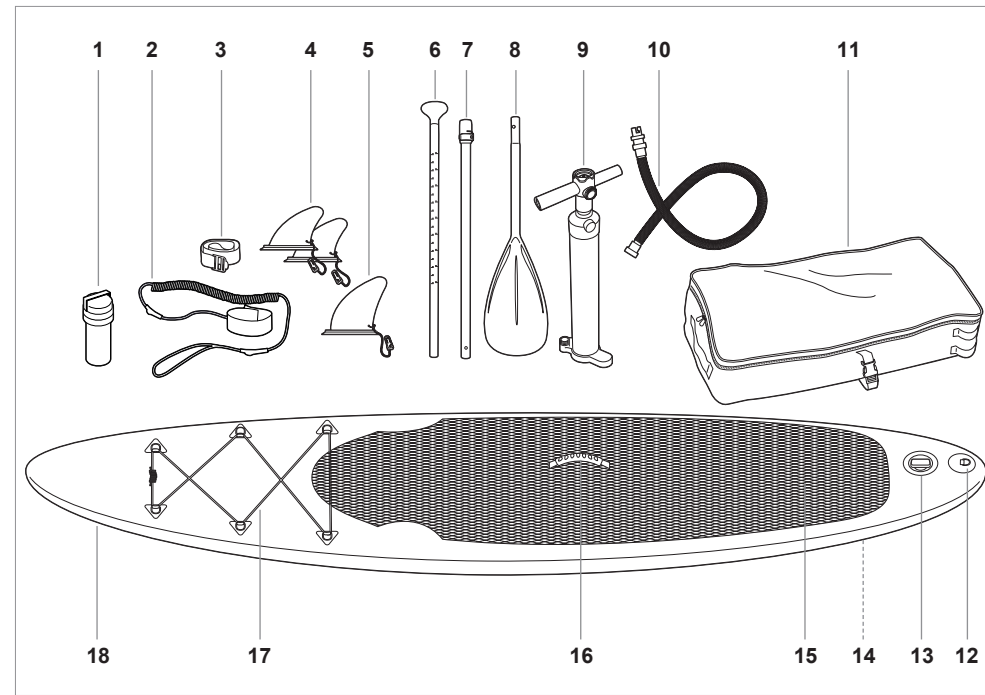

**A**

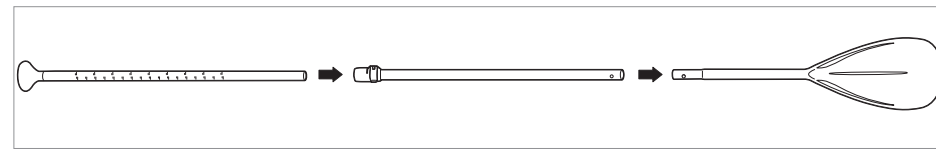

**A1**

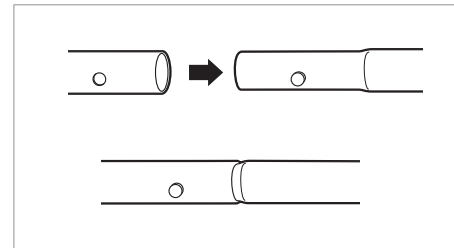

**A2**

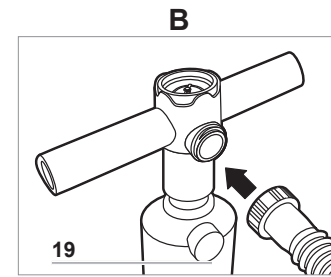
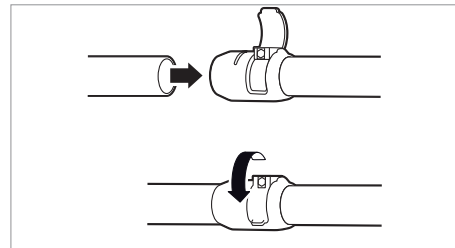

**B**

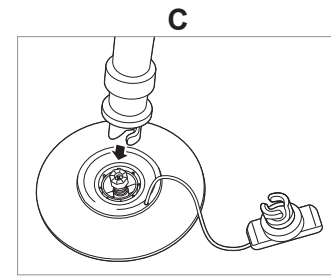

**C**

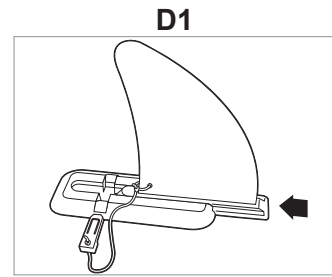

**D1**

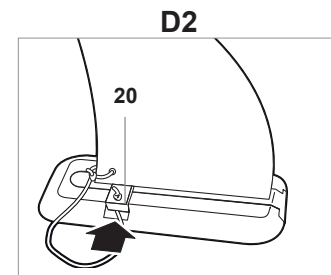

**D2**

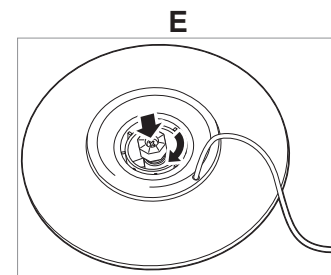

**E**

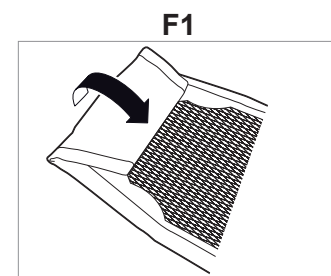

**F1**

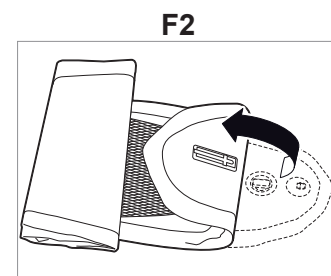

**F2**

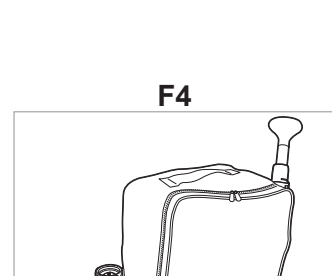

**F4**

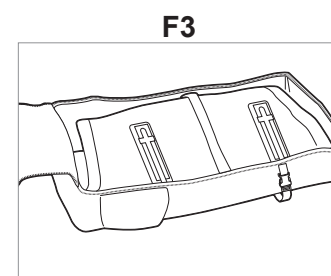

**F3**

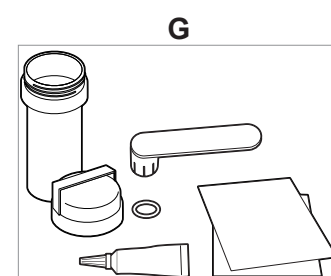

**G**

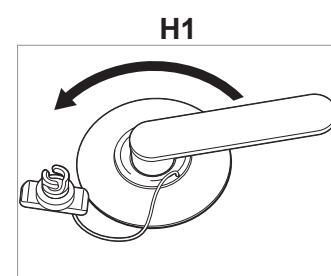

**H1**

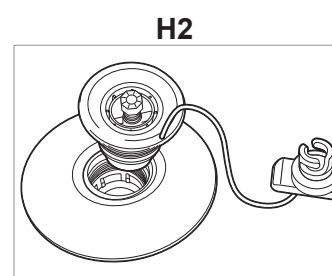

**H2**