

PDF Compressor Free Version

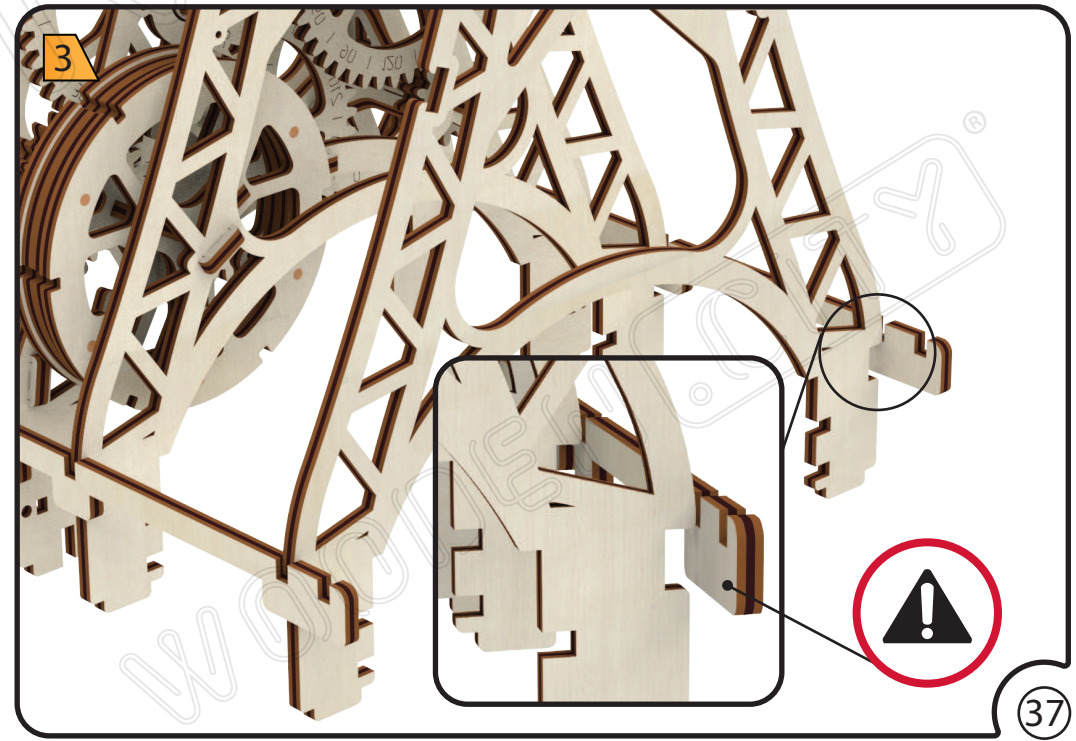

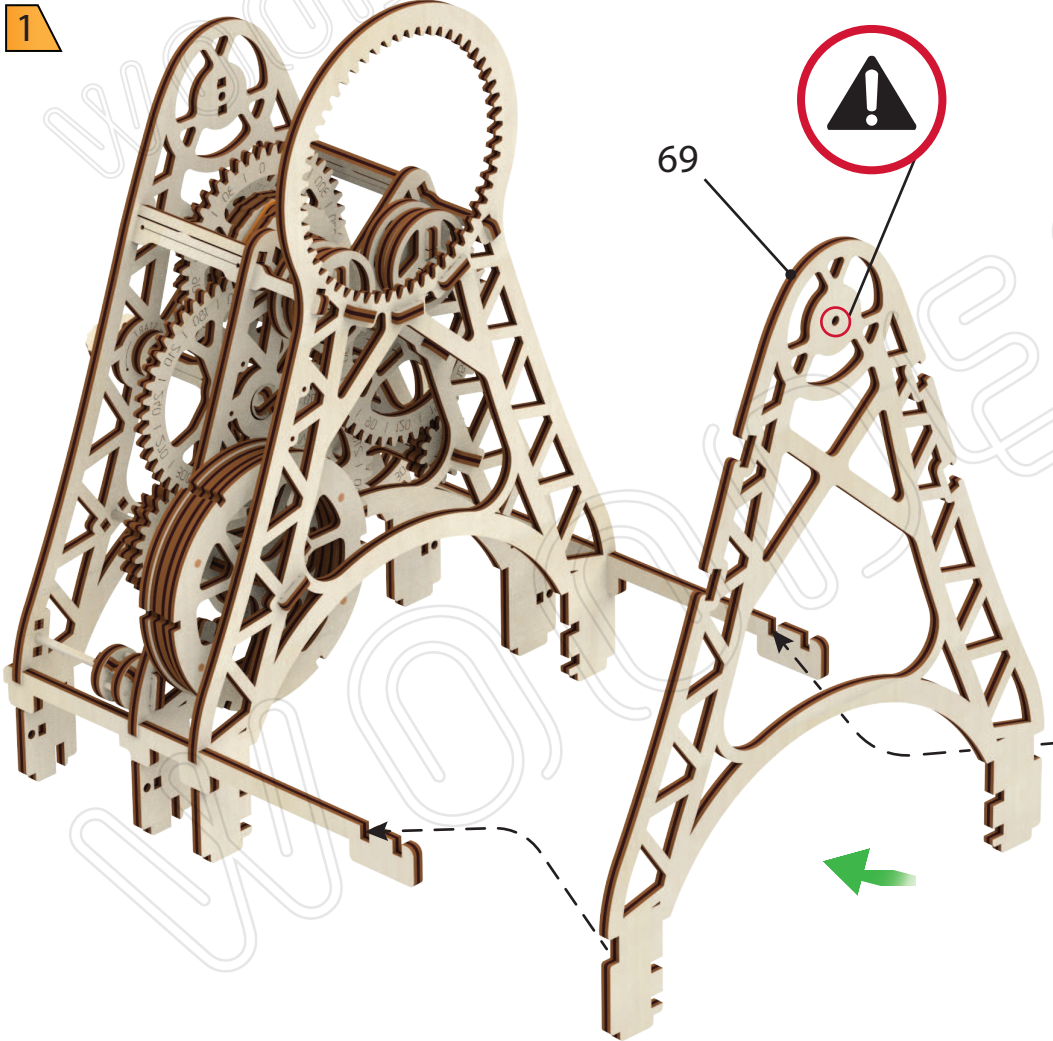

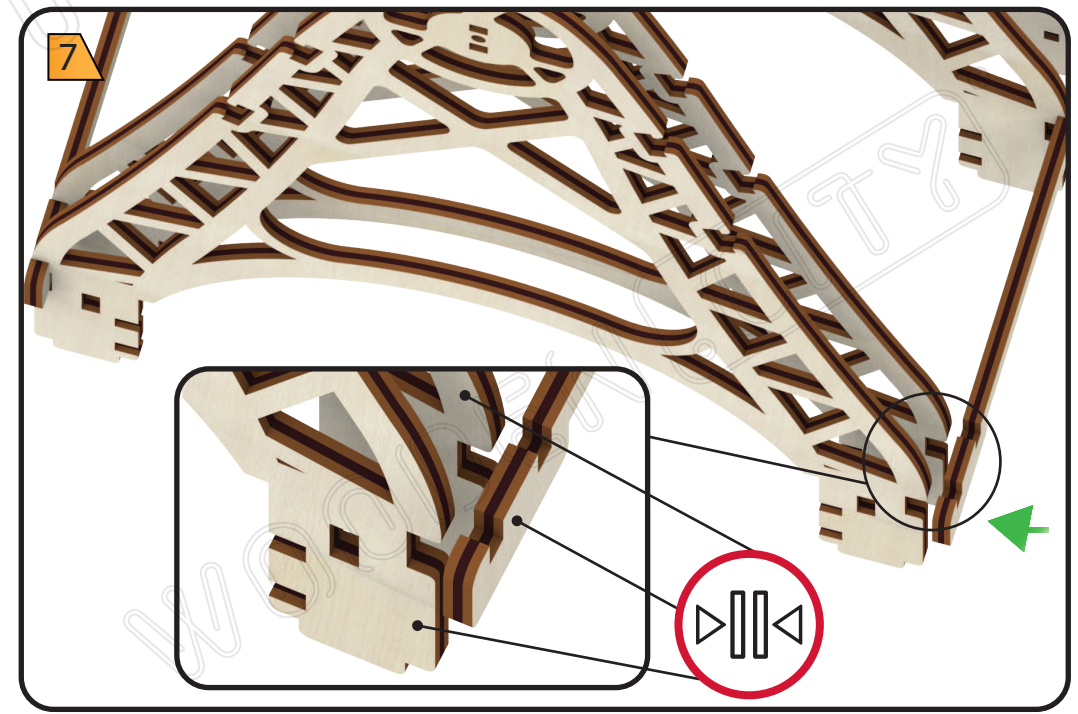

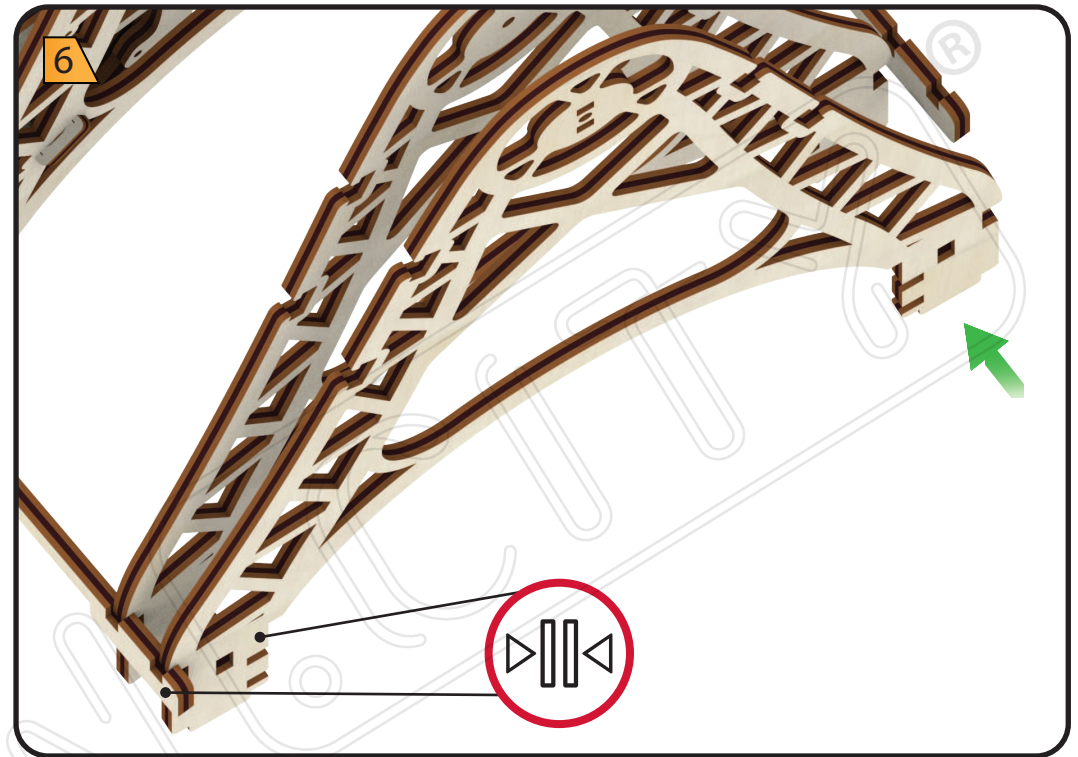
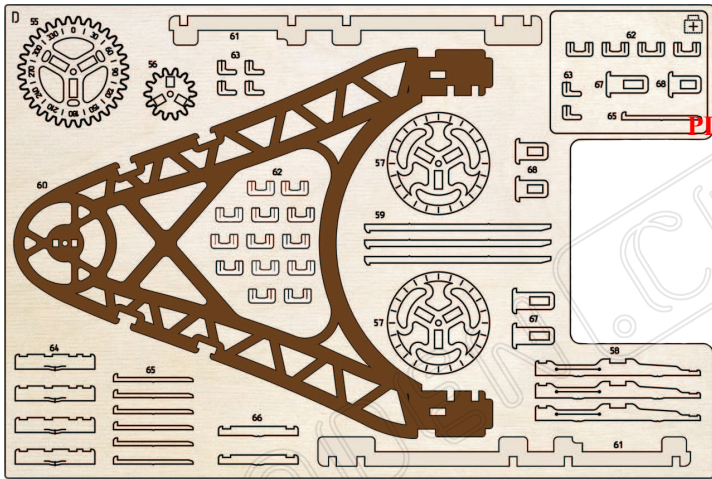
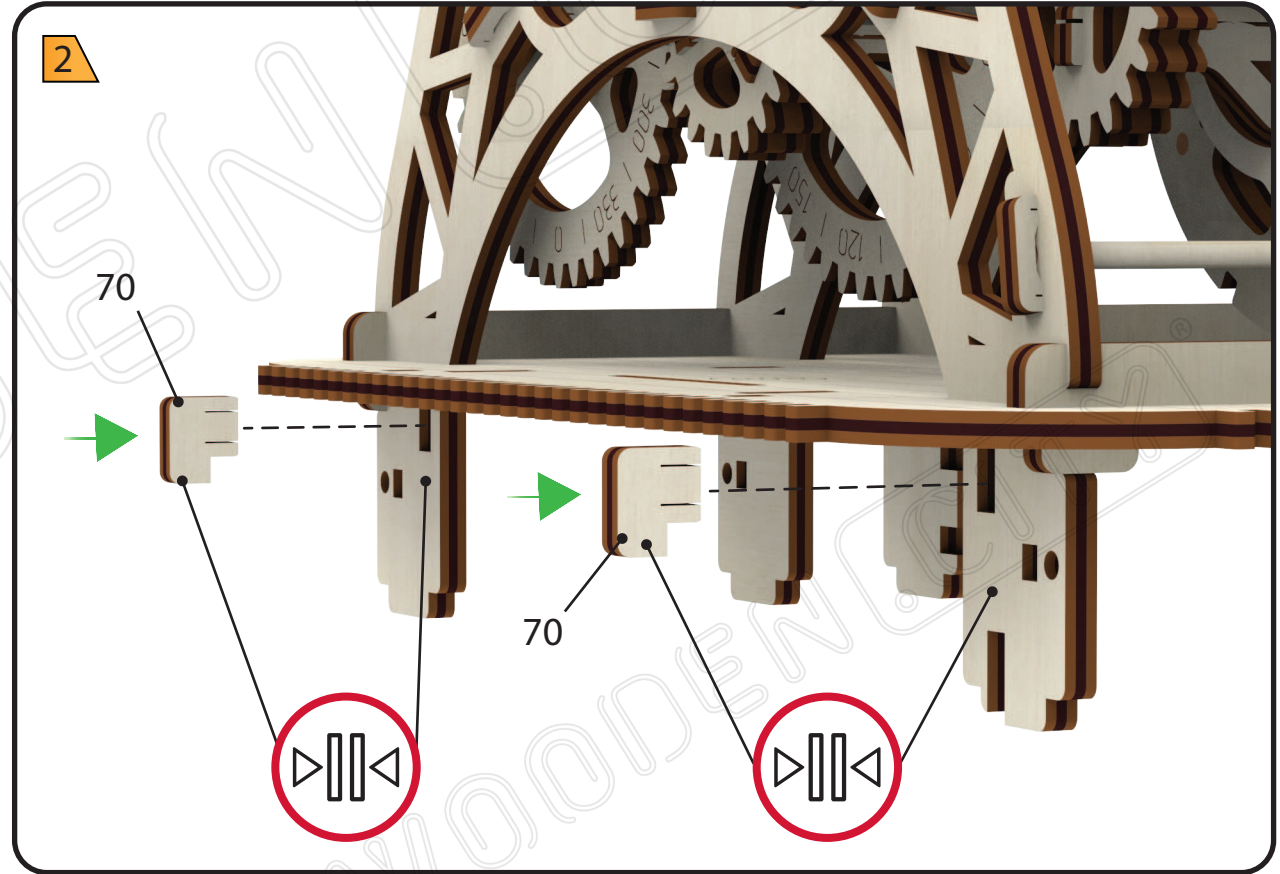
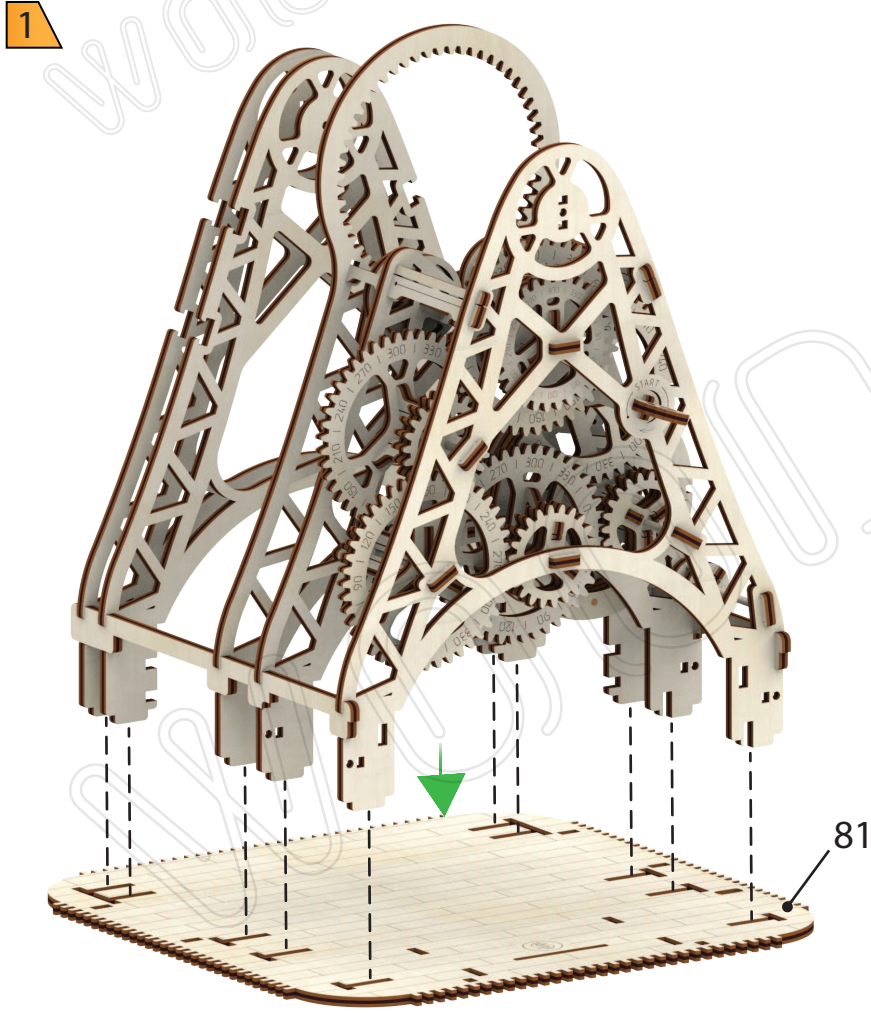
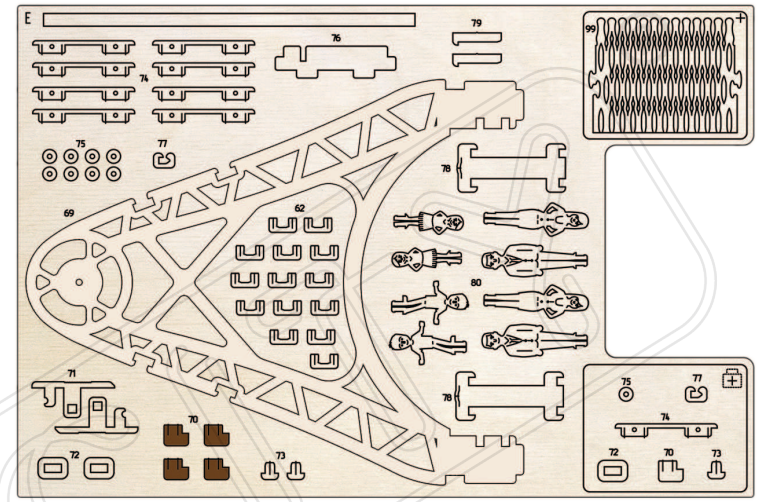
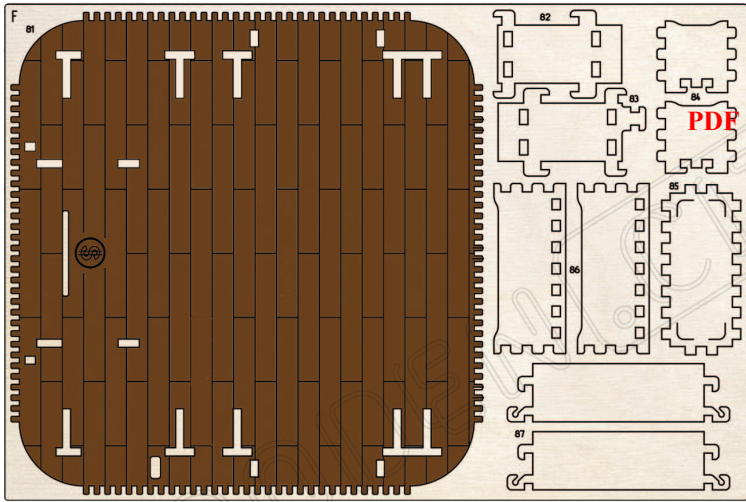
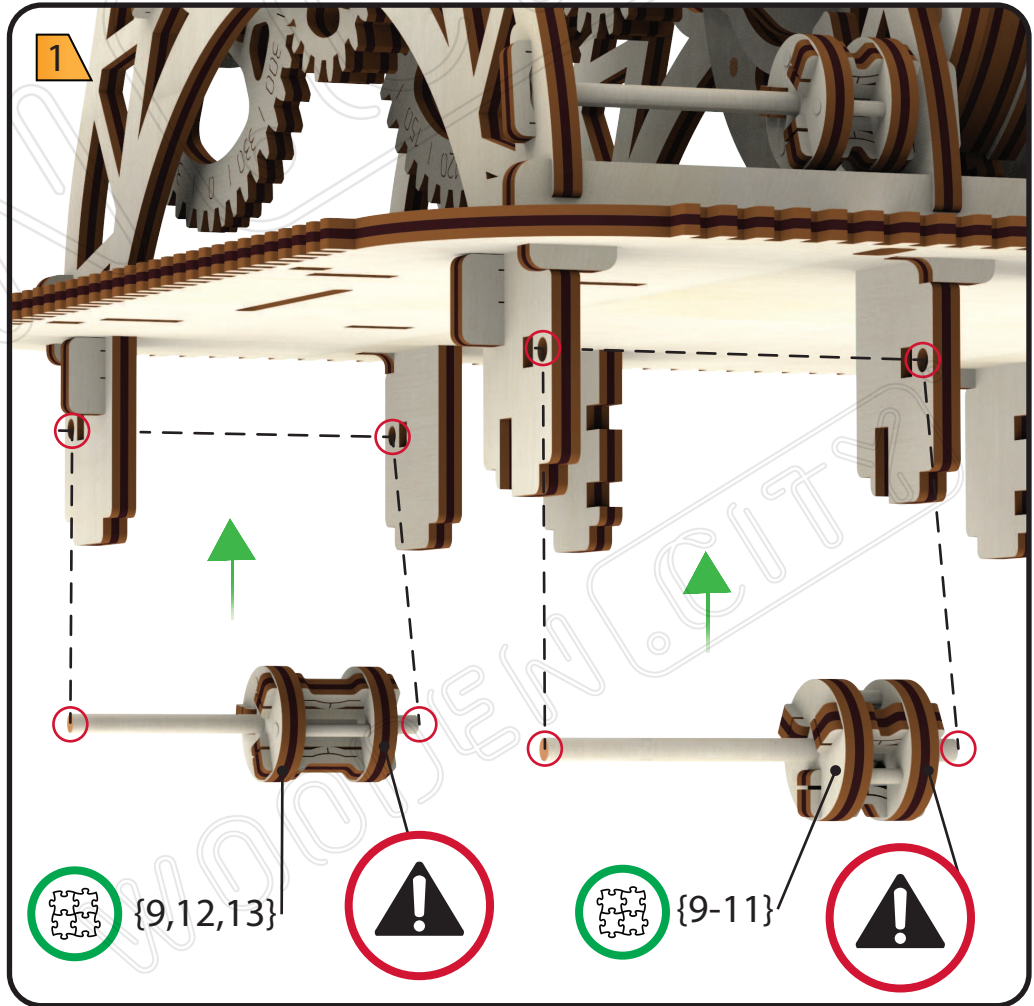
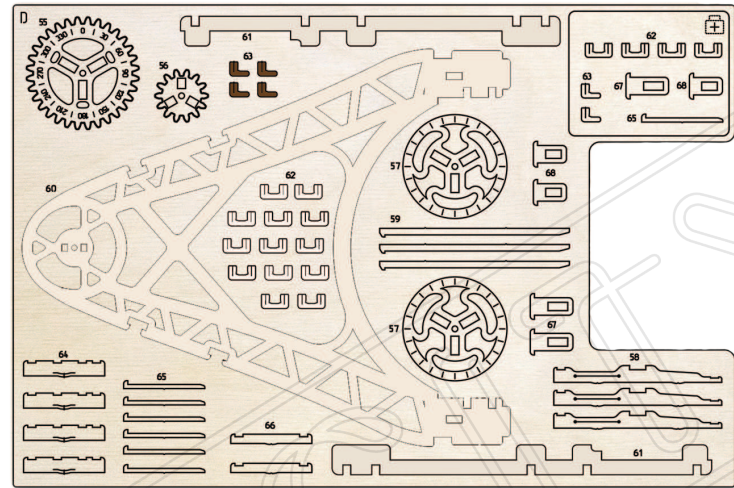
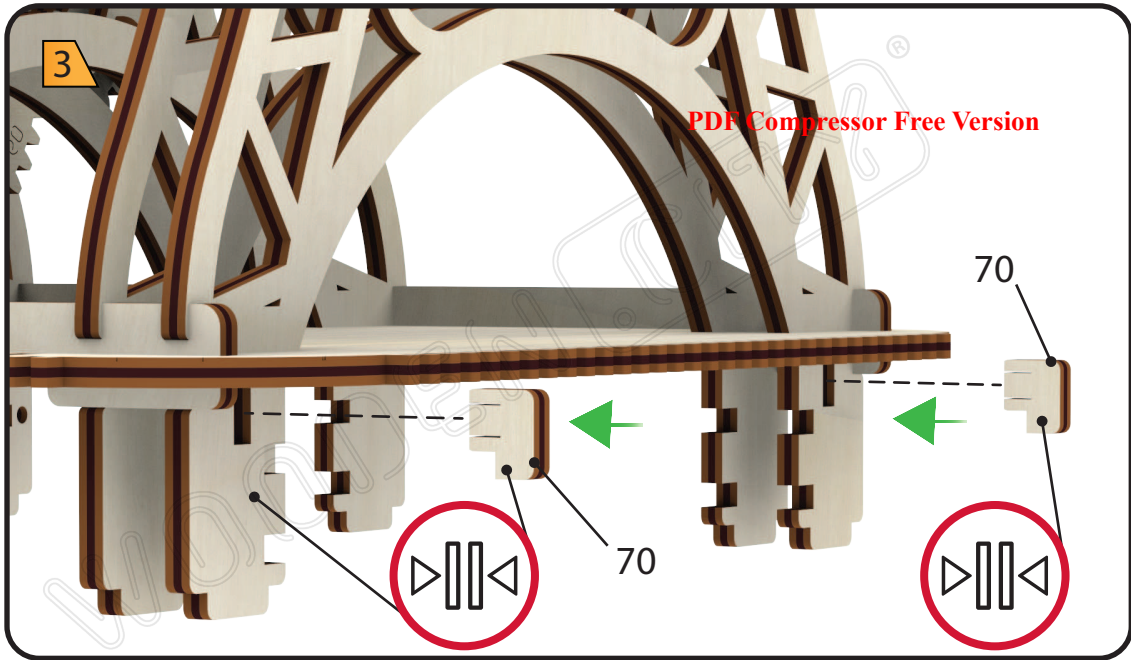

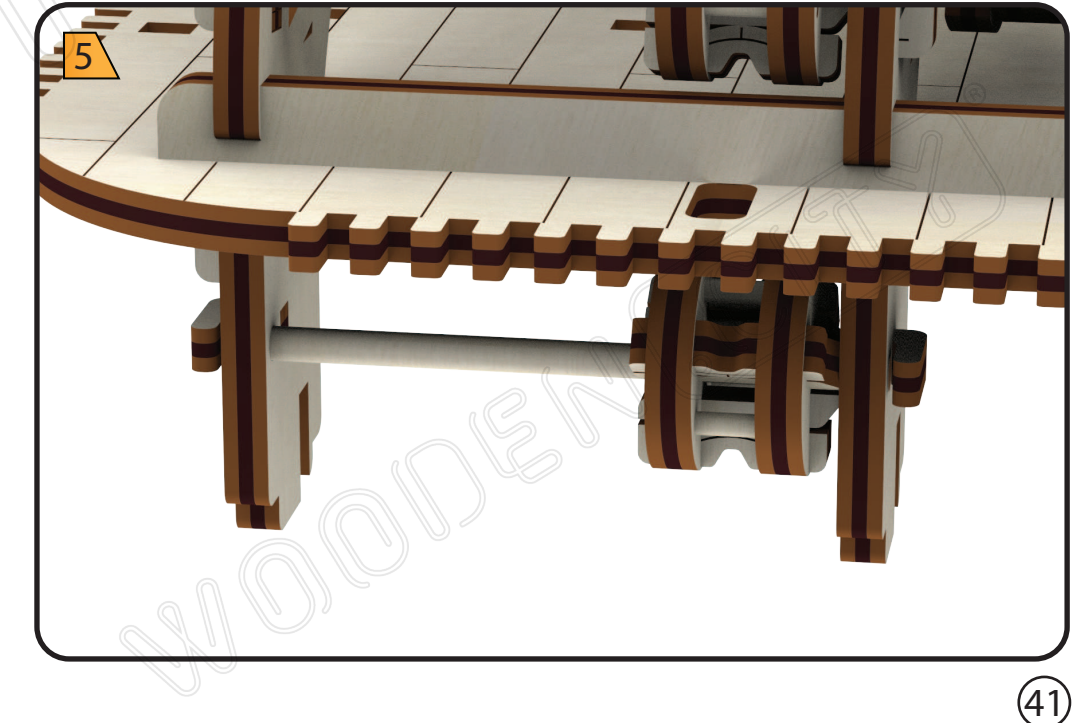
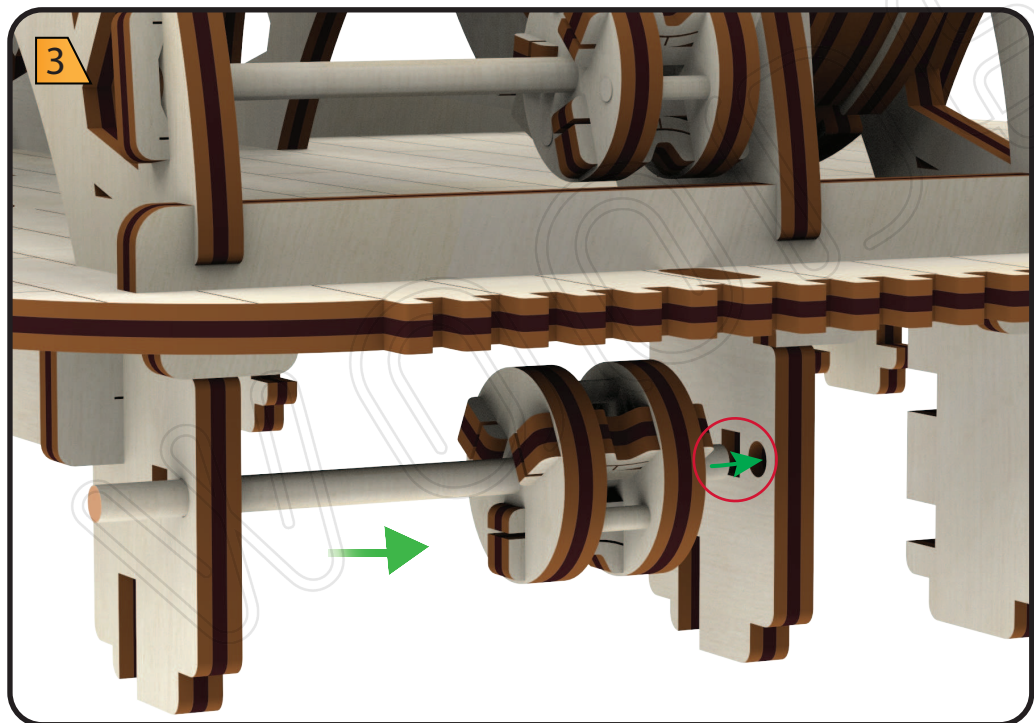
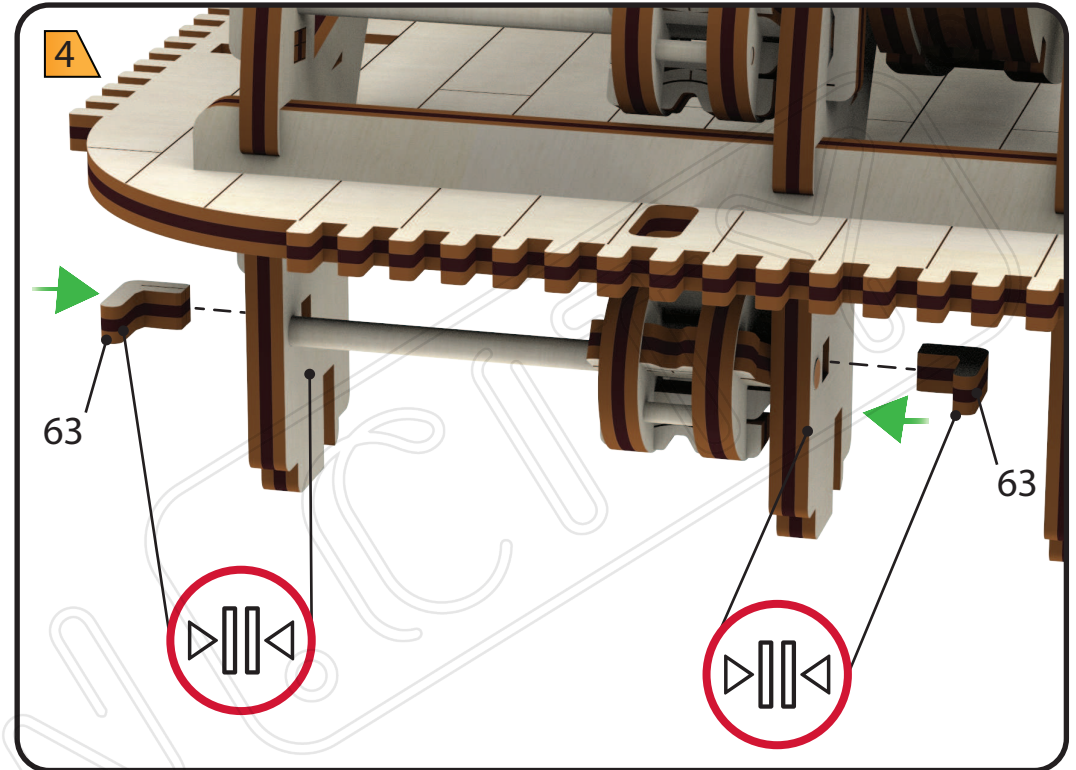
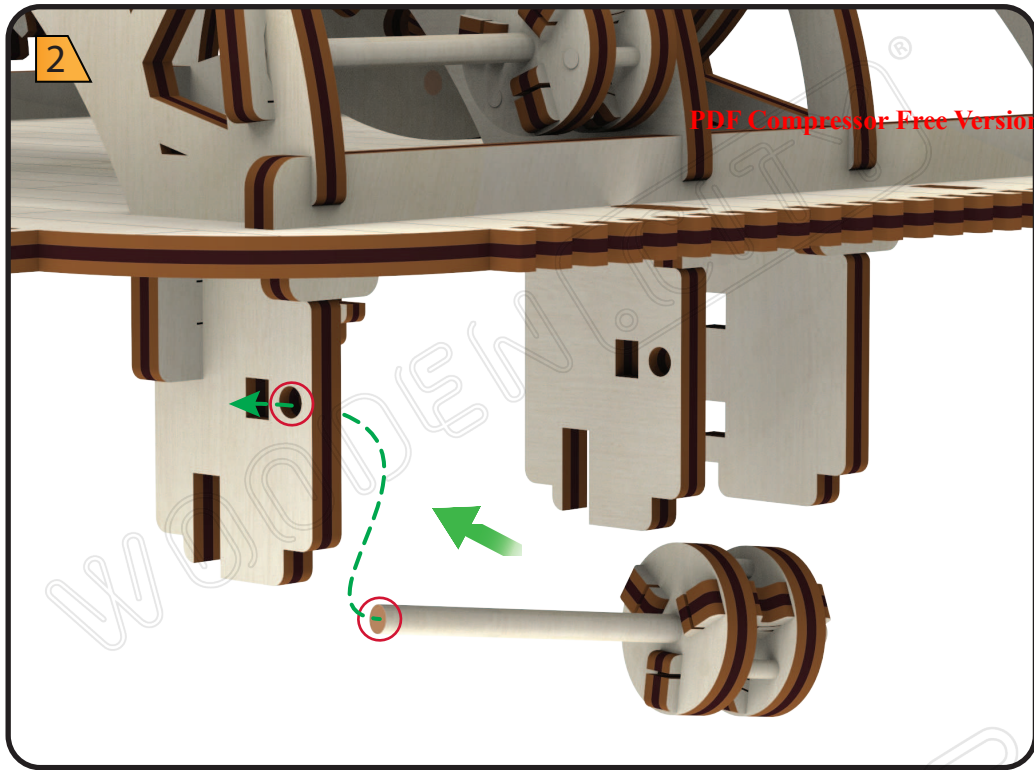

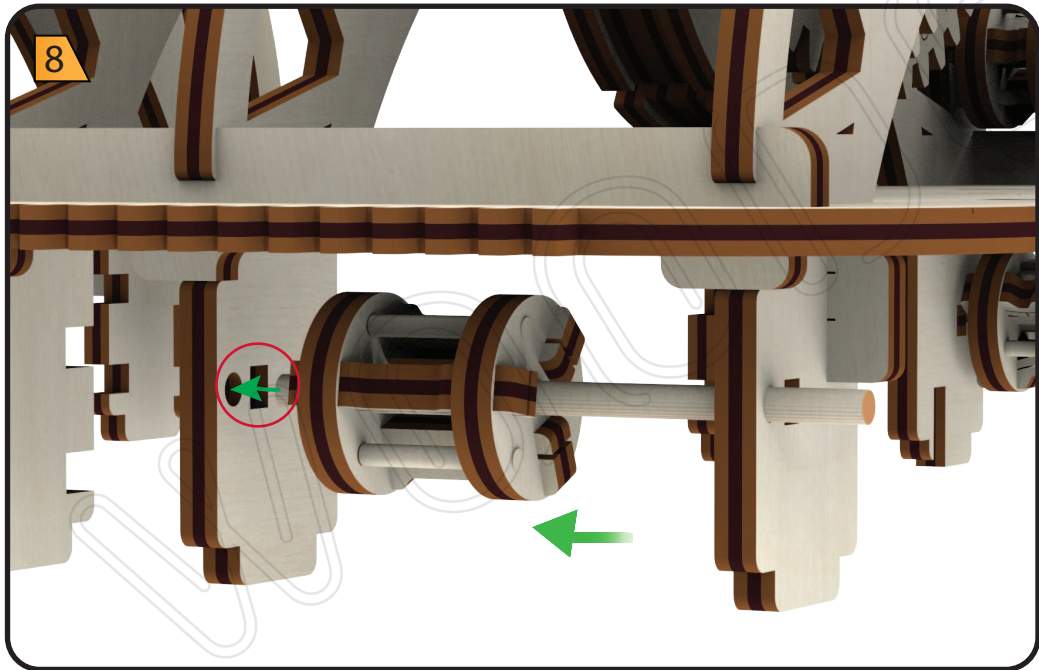
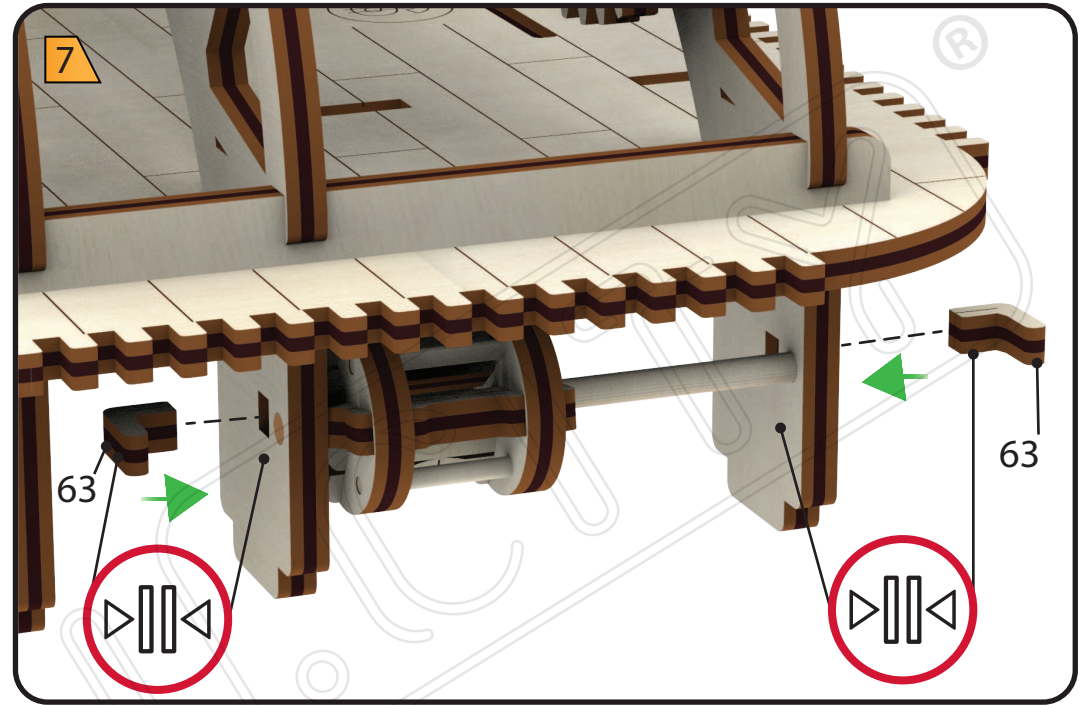
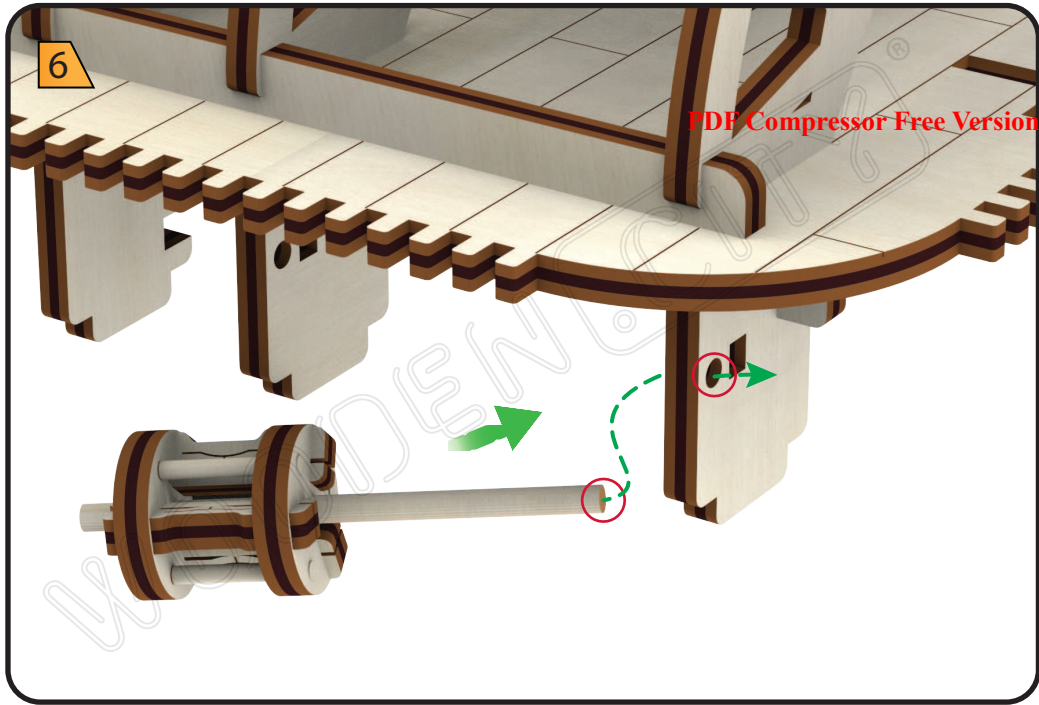

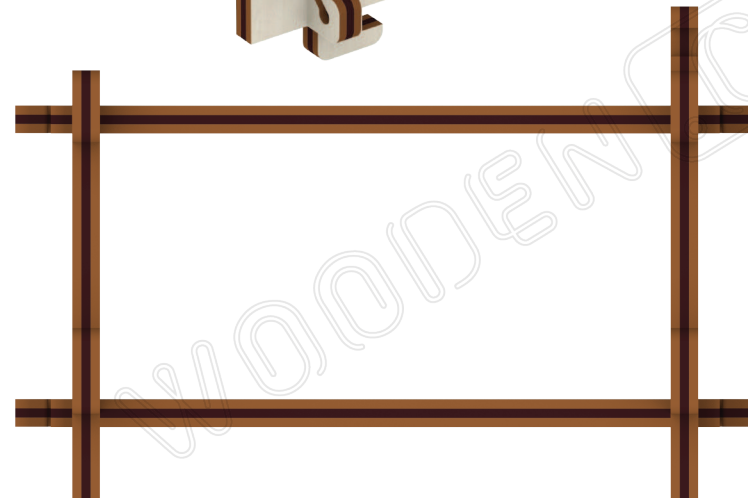
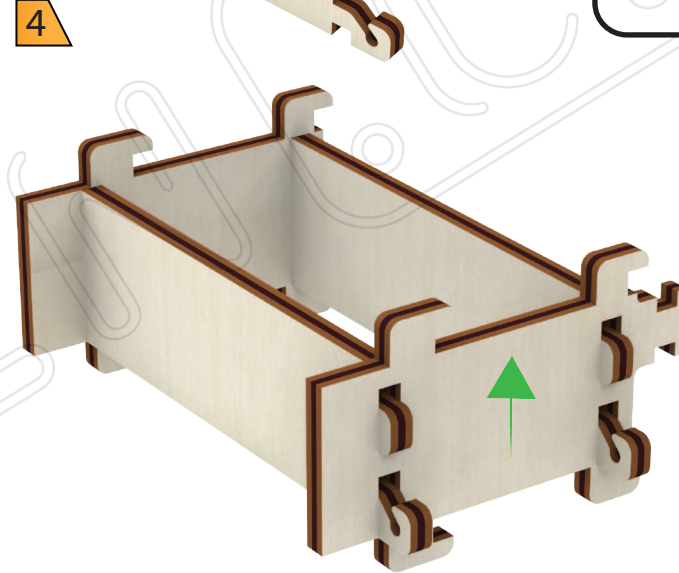
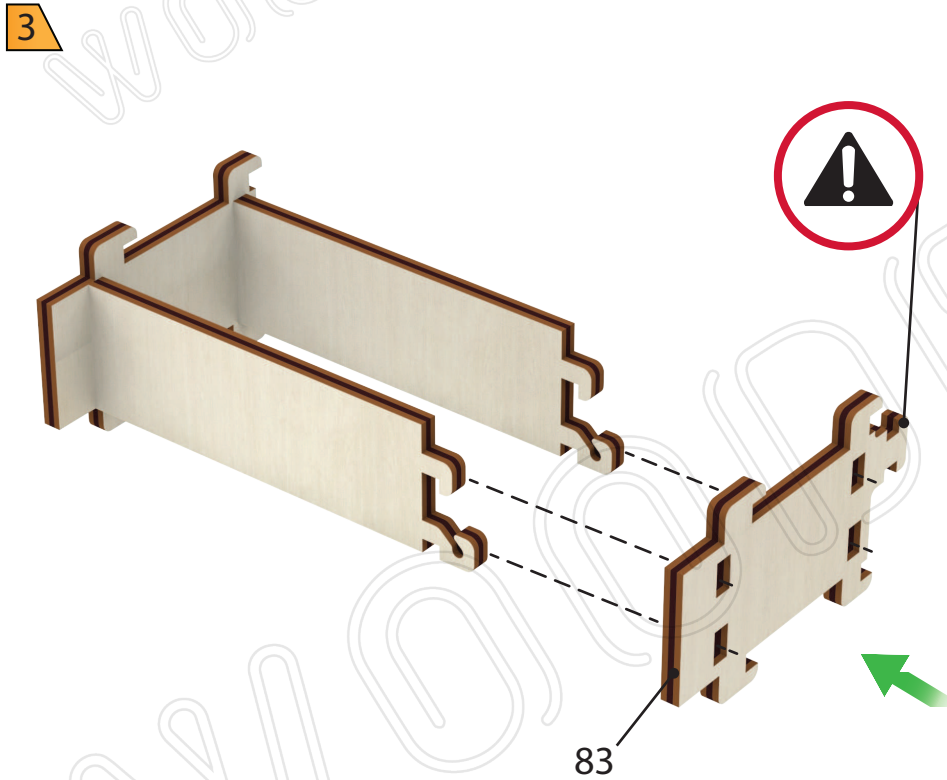
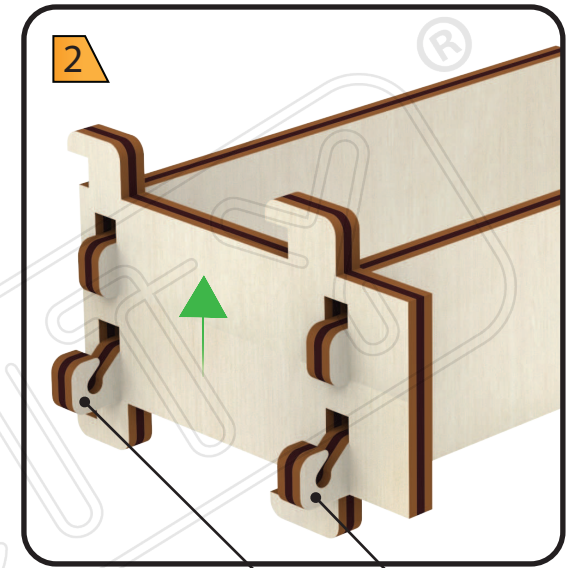
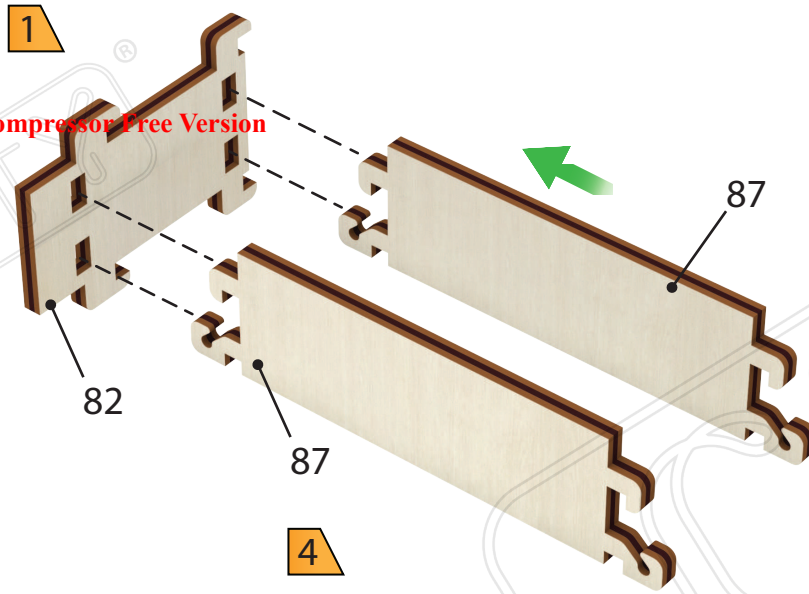
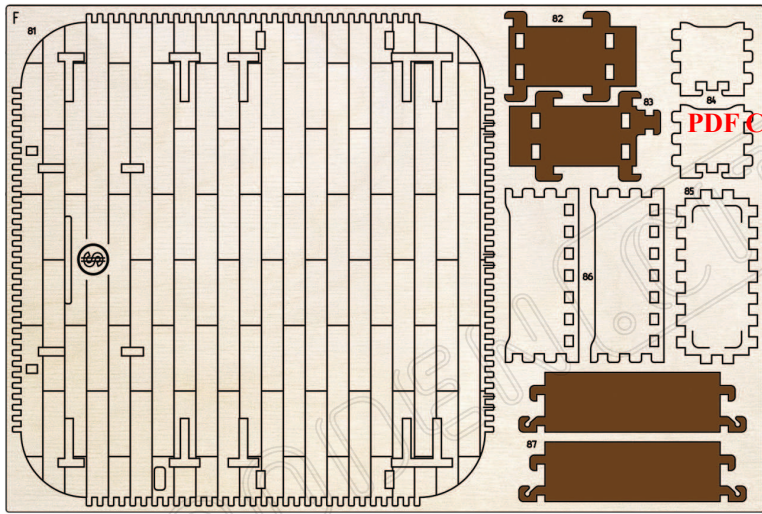

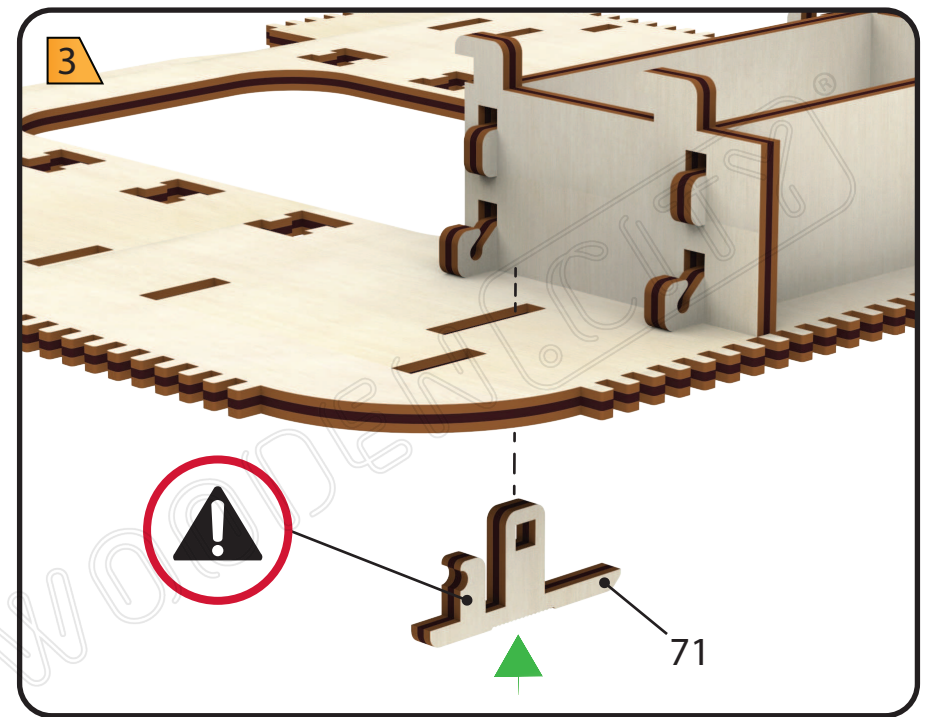
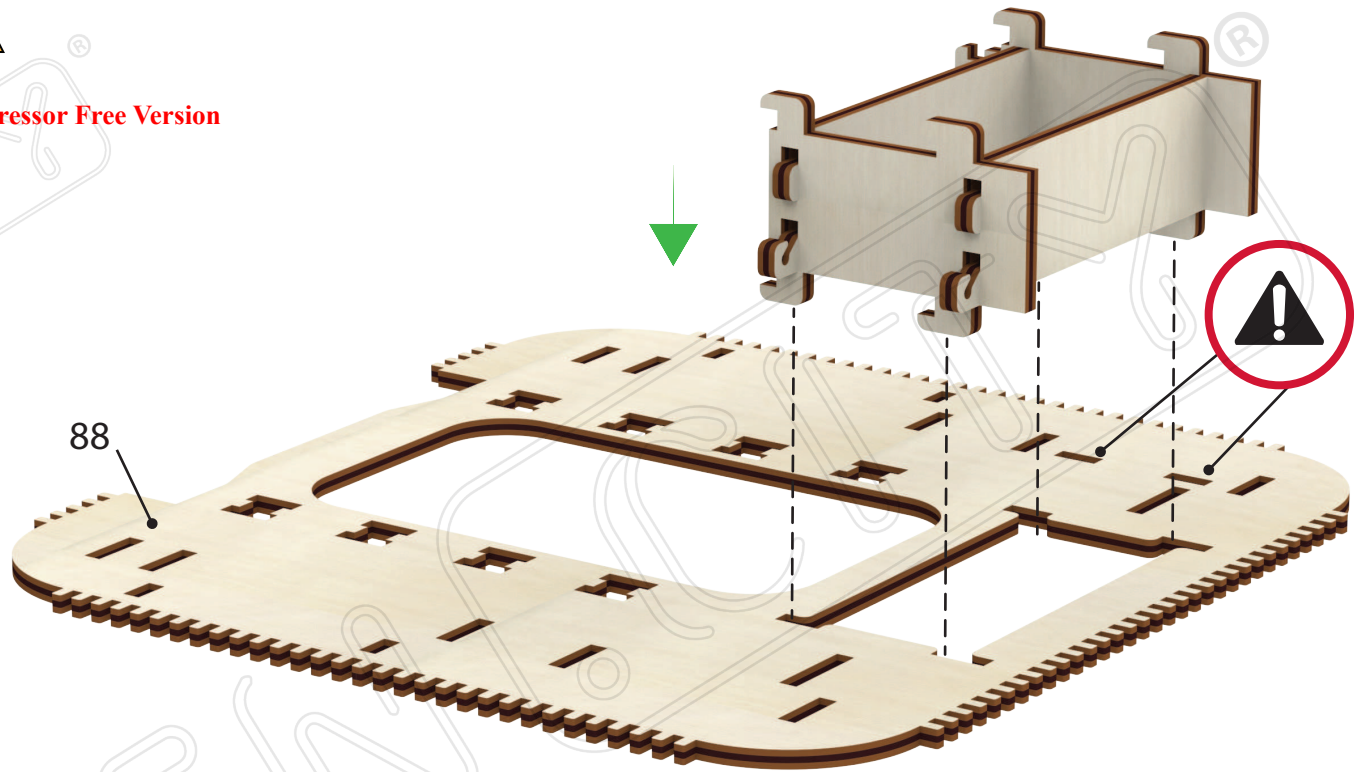
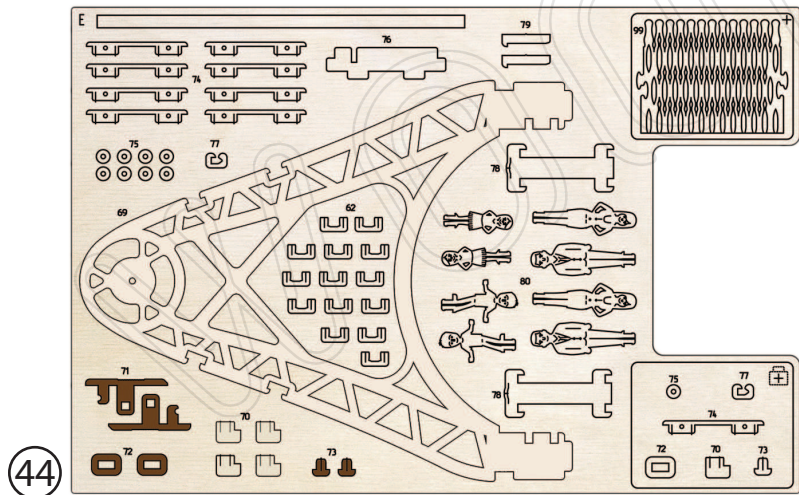
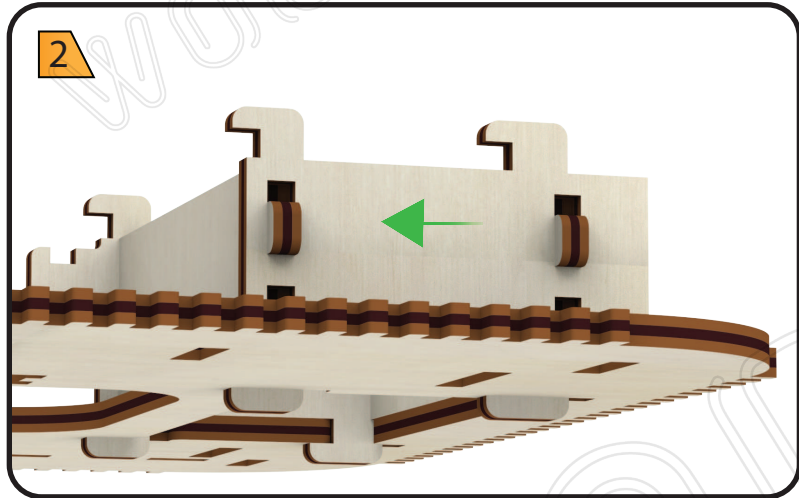
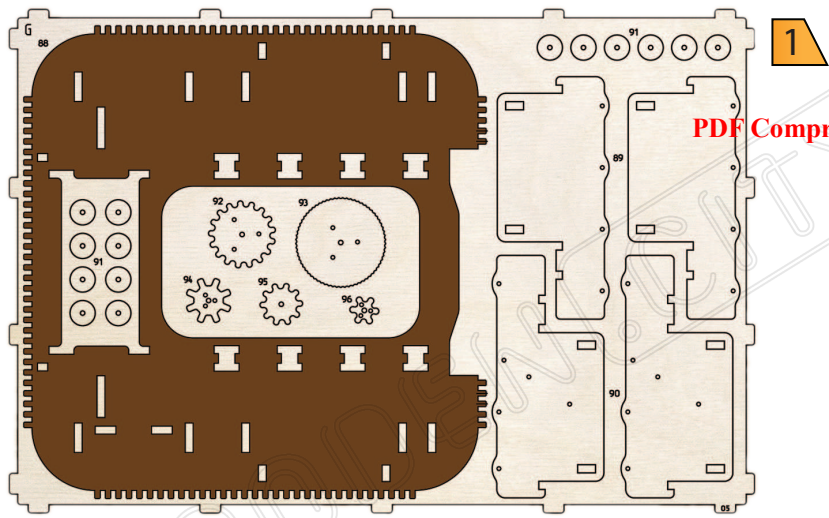



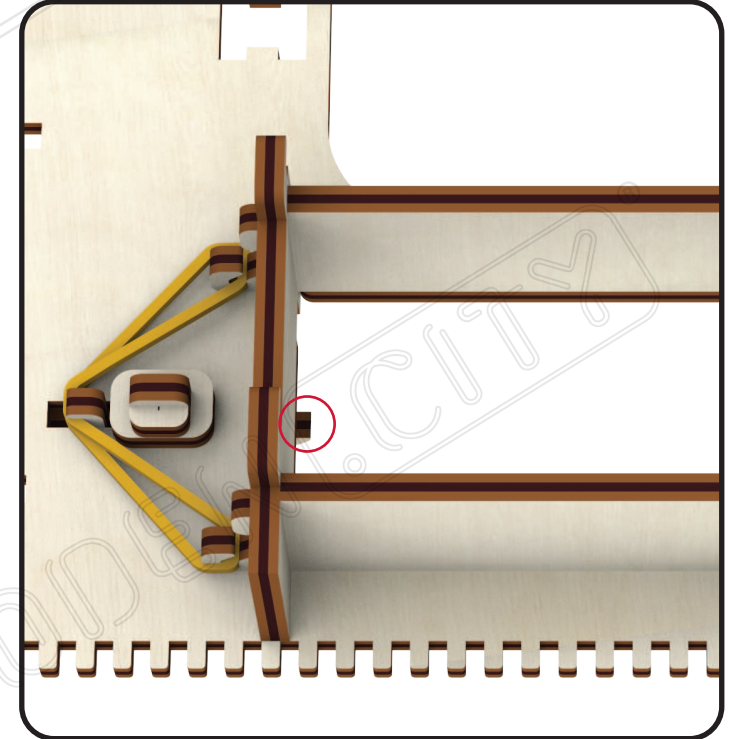
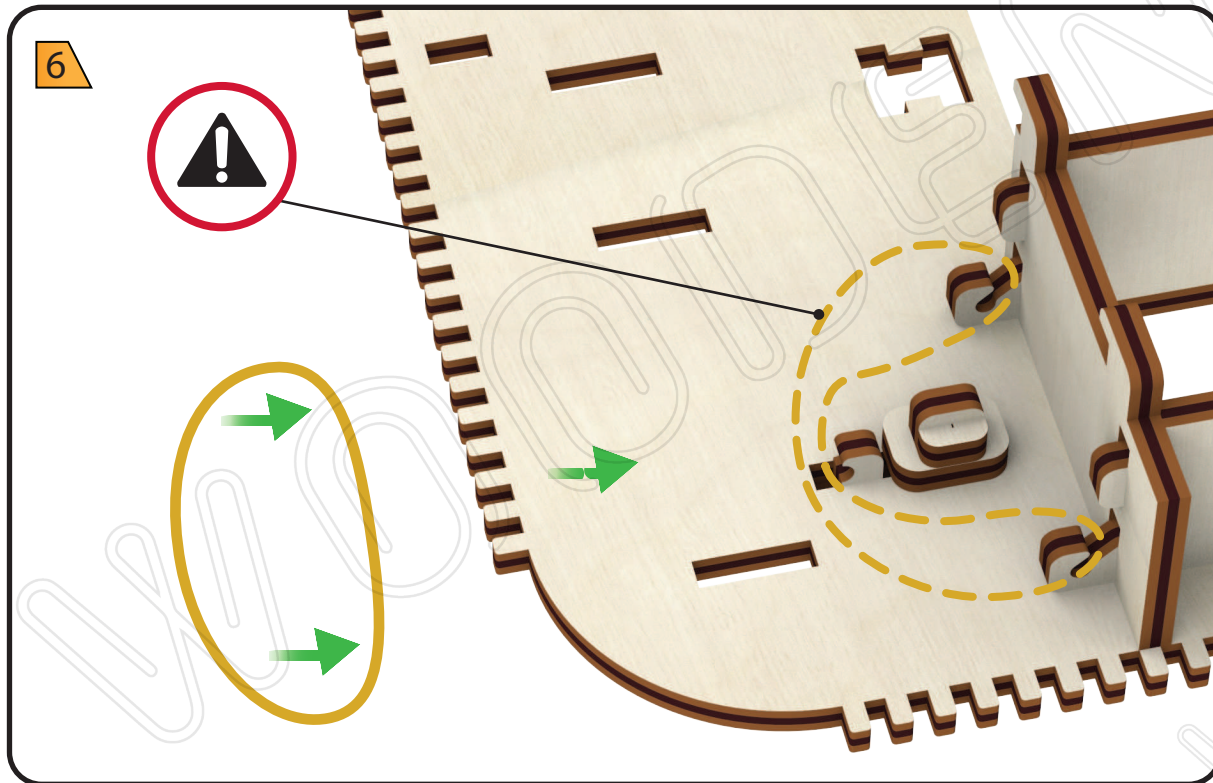
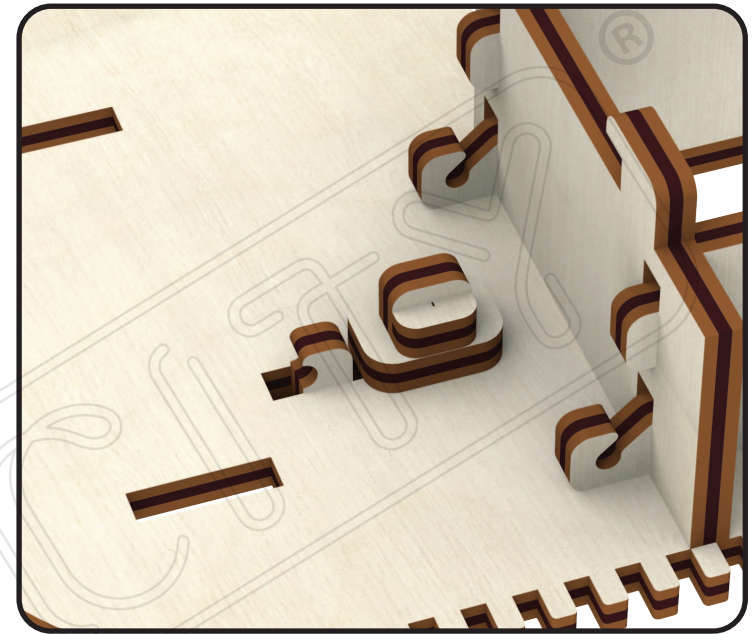
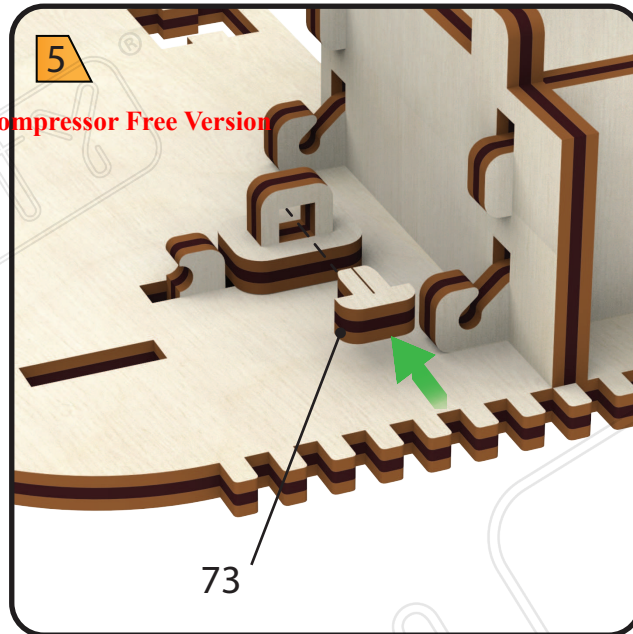
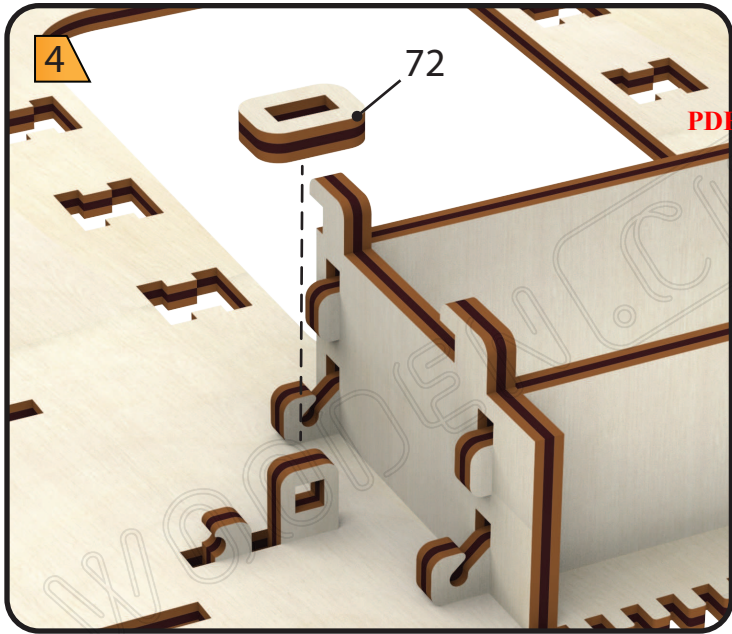

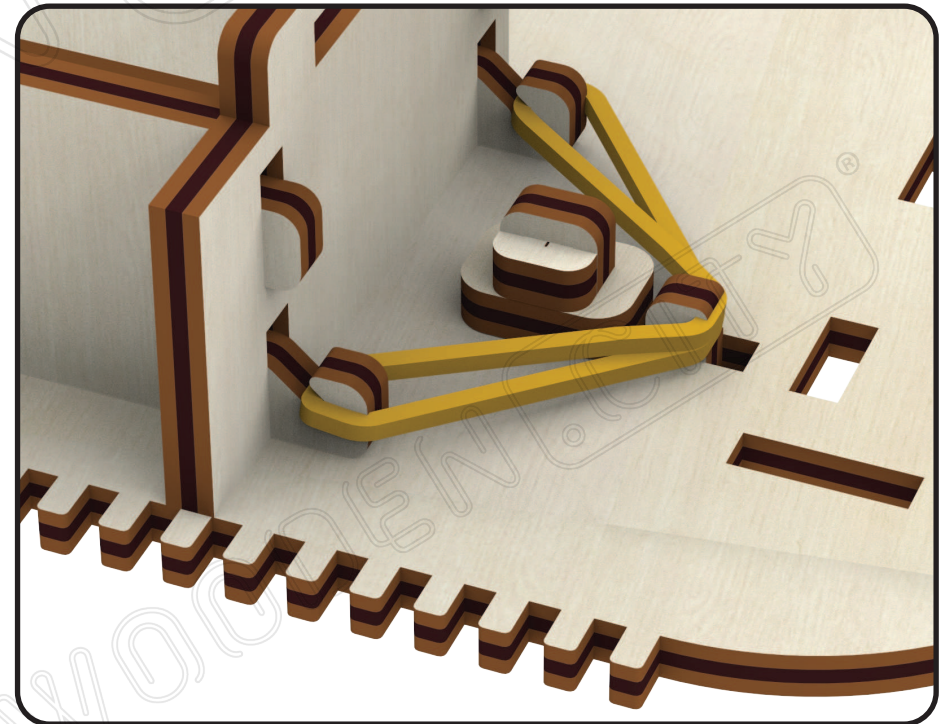
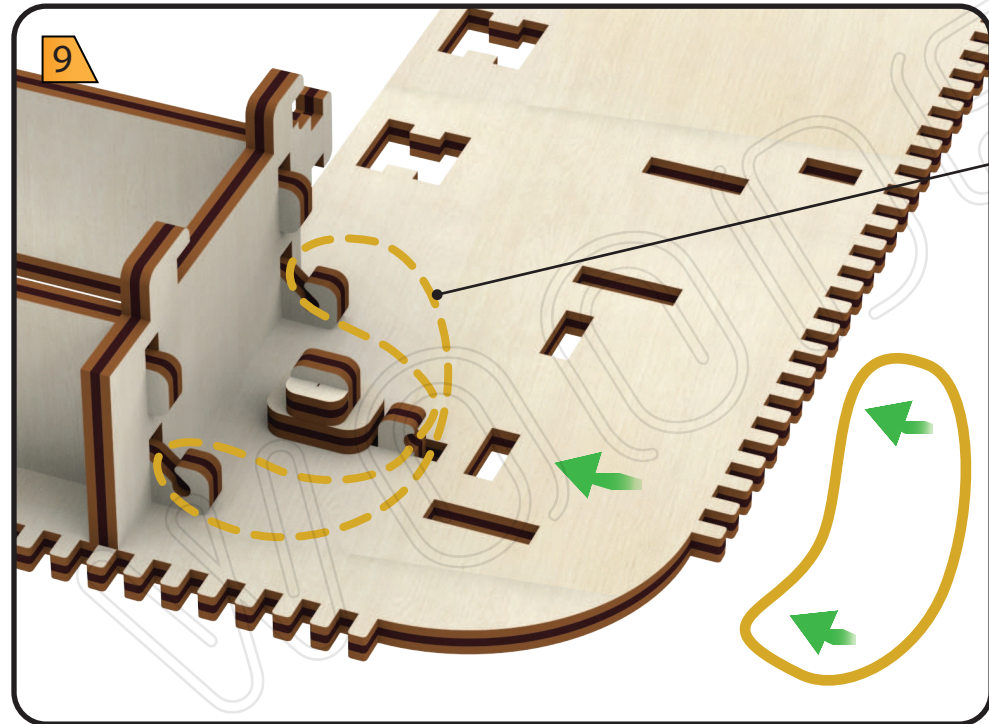
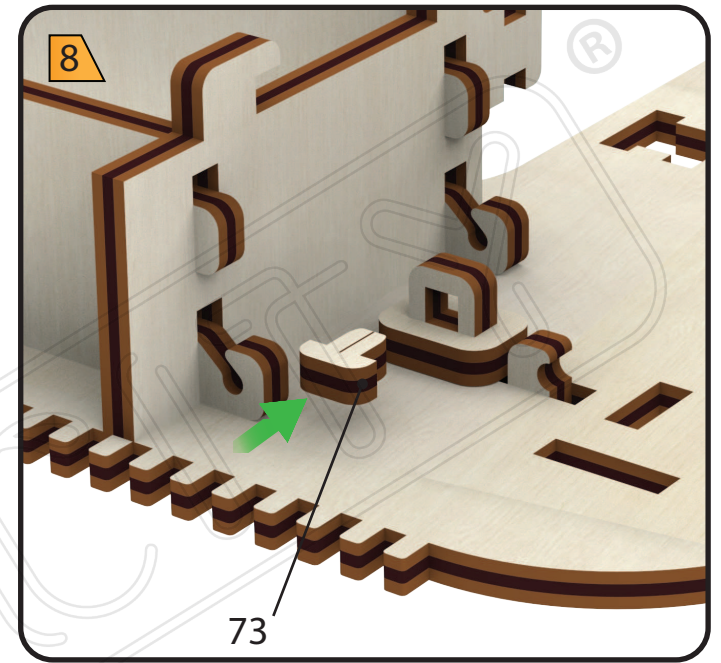
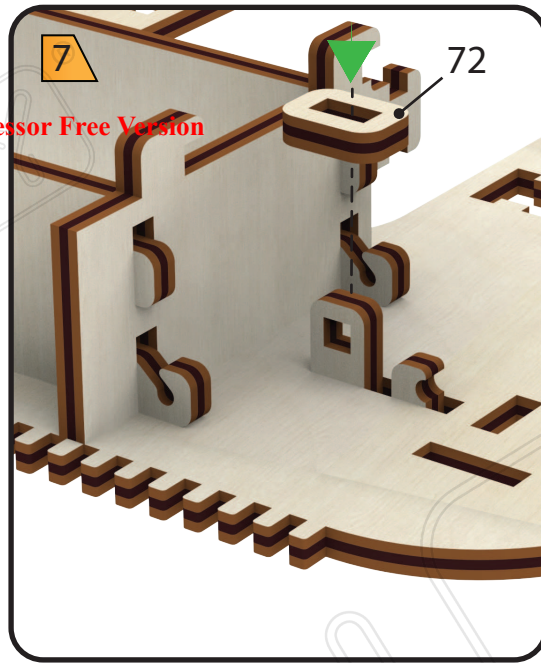
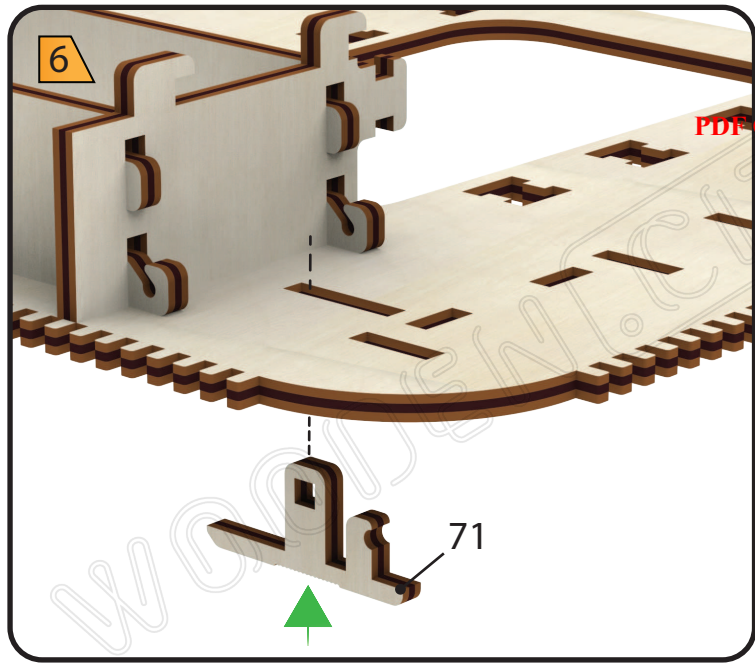

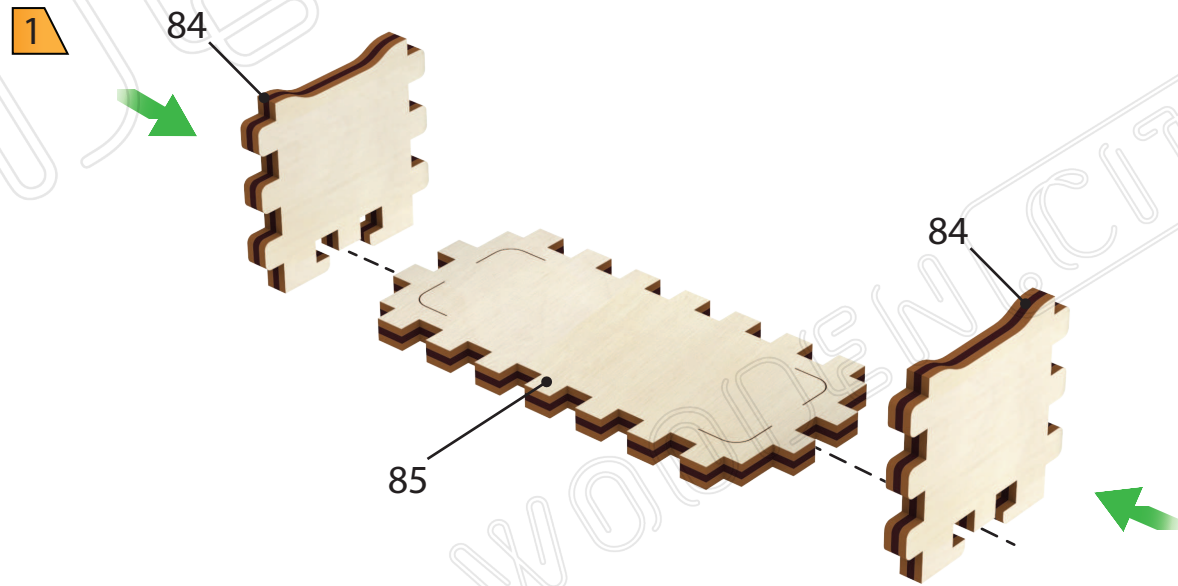
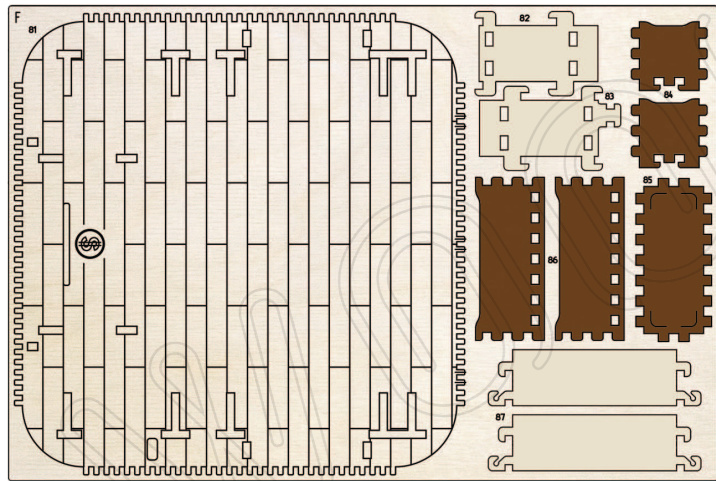
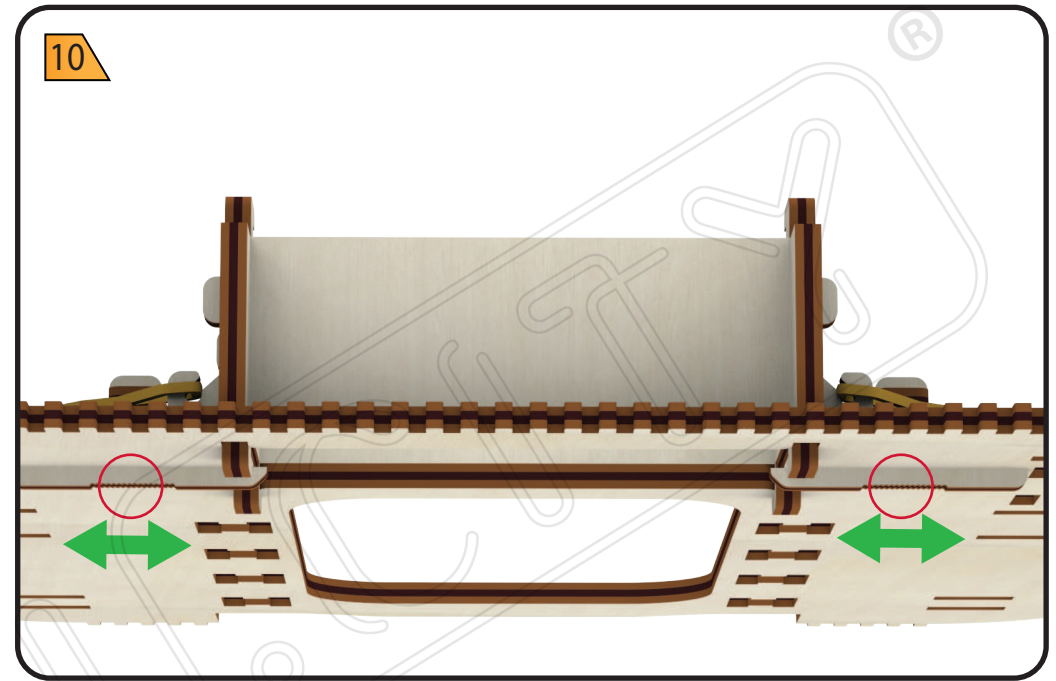
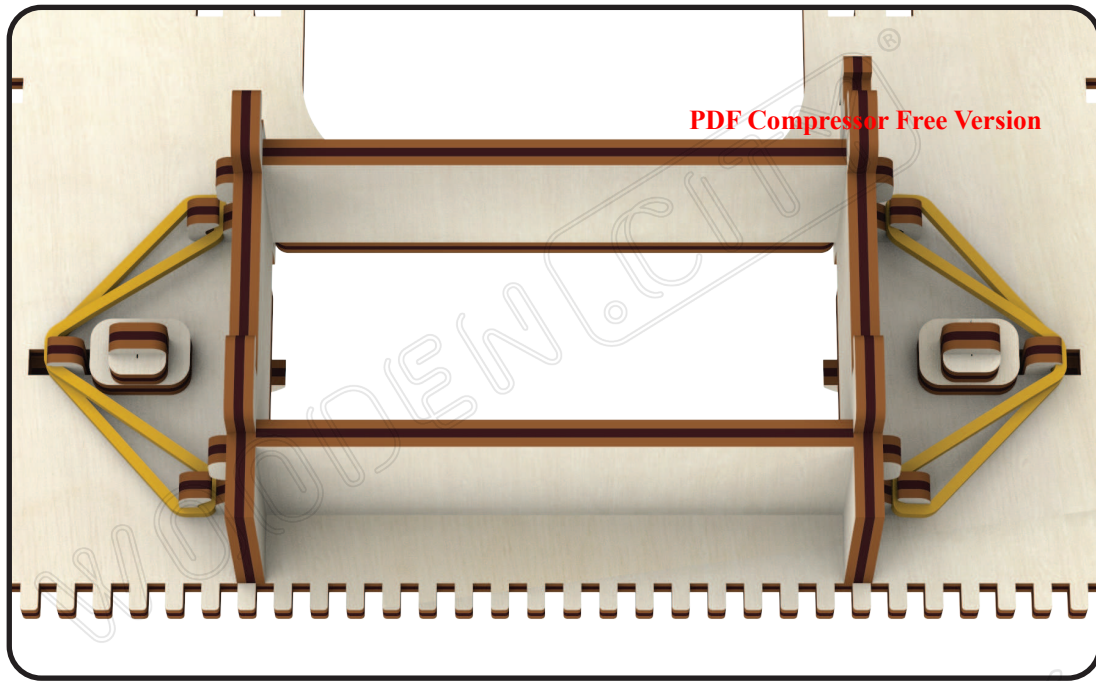

2

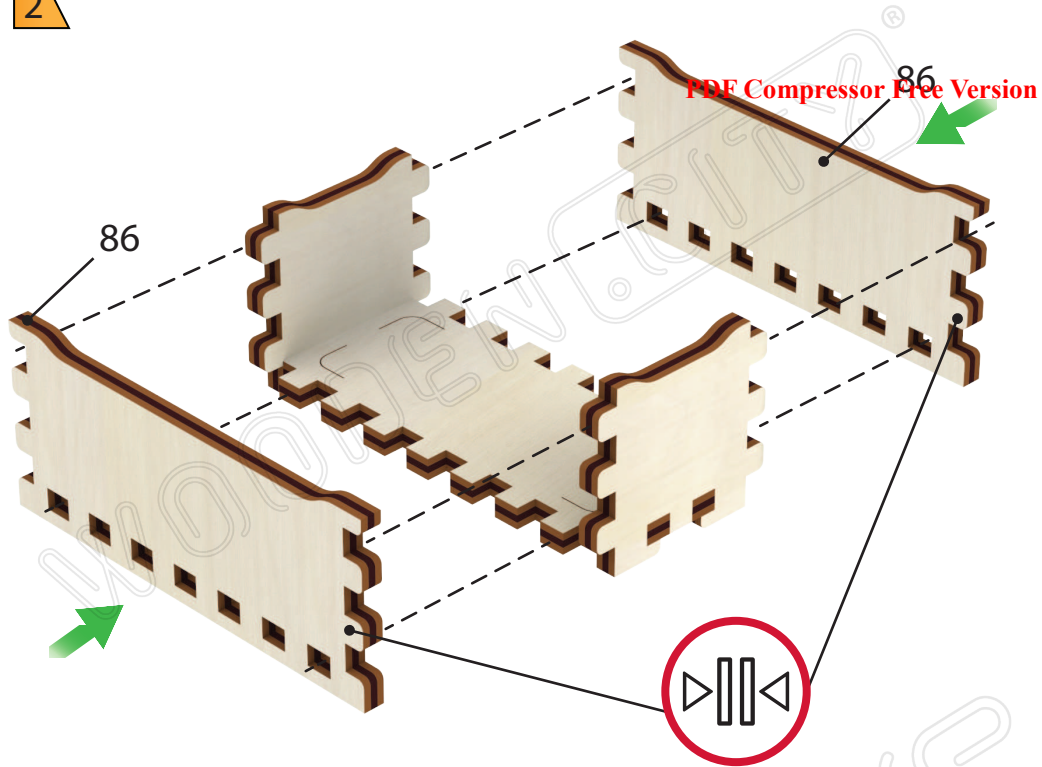

3

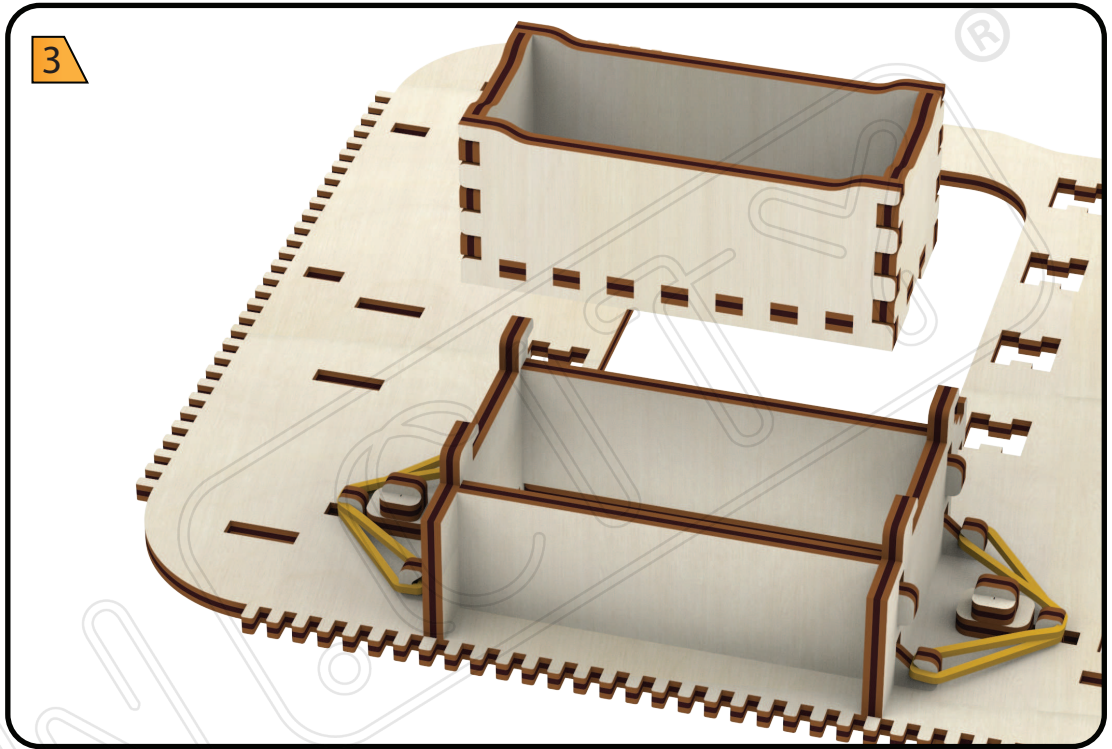

4

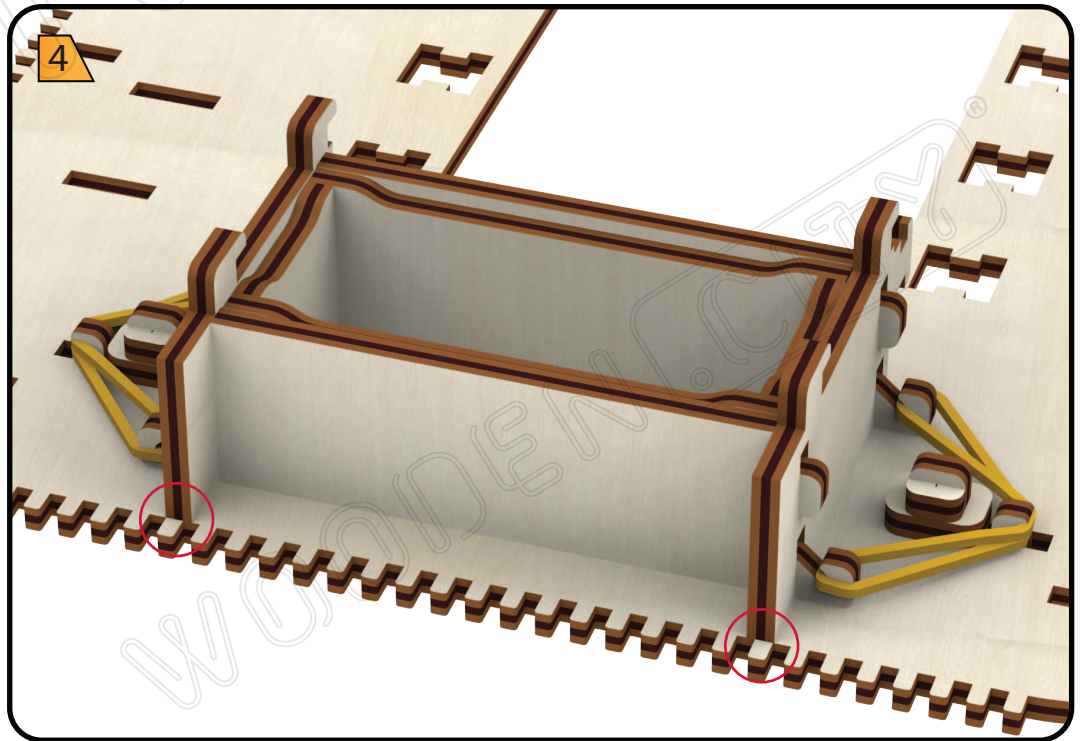

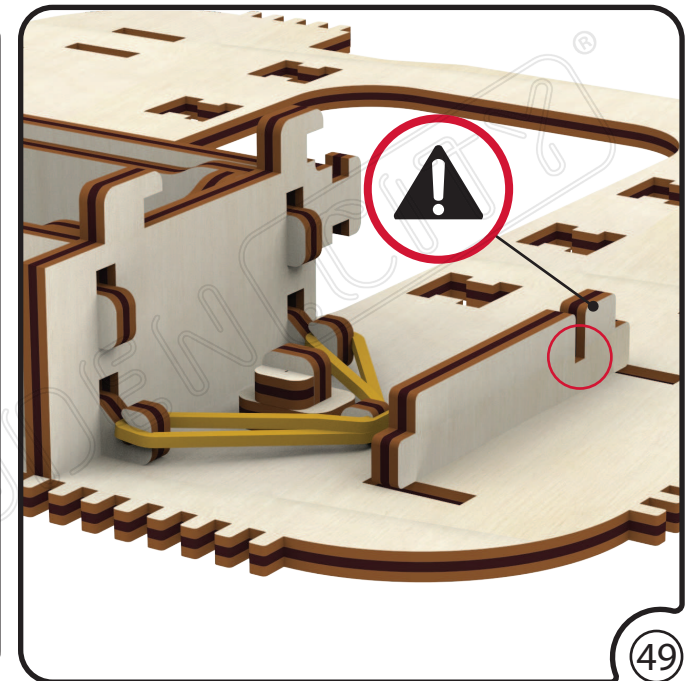
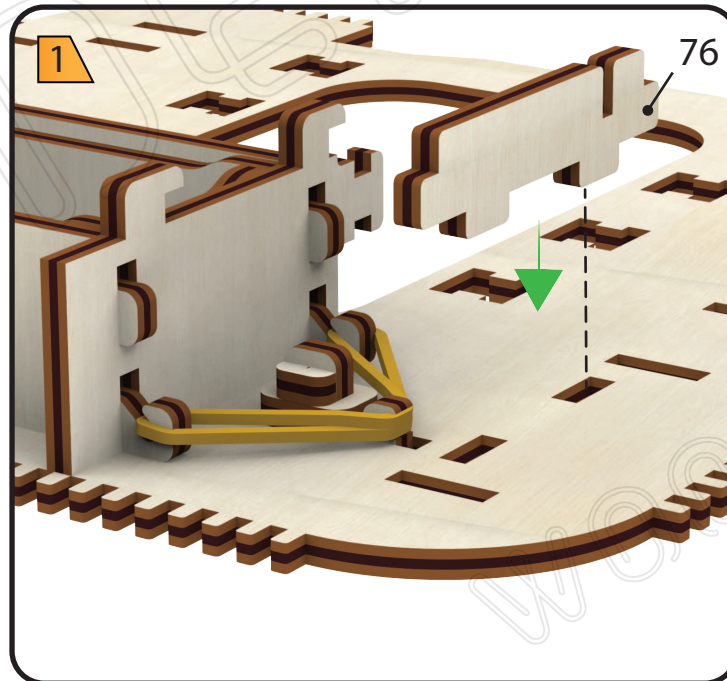
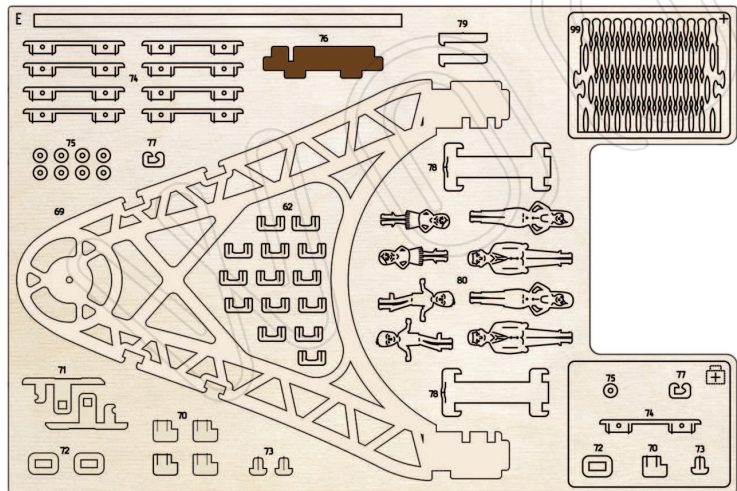
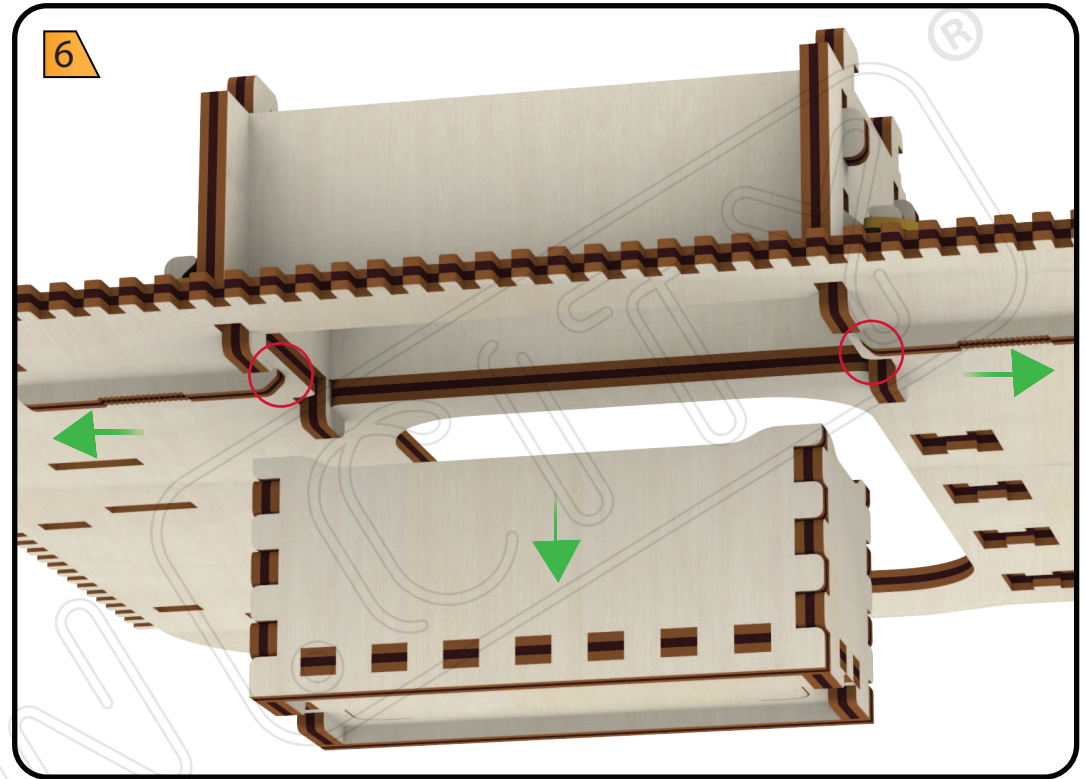
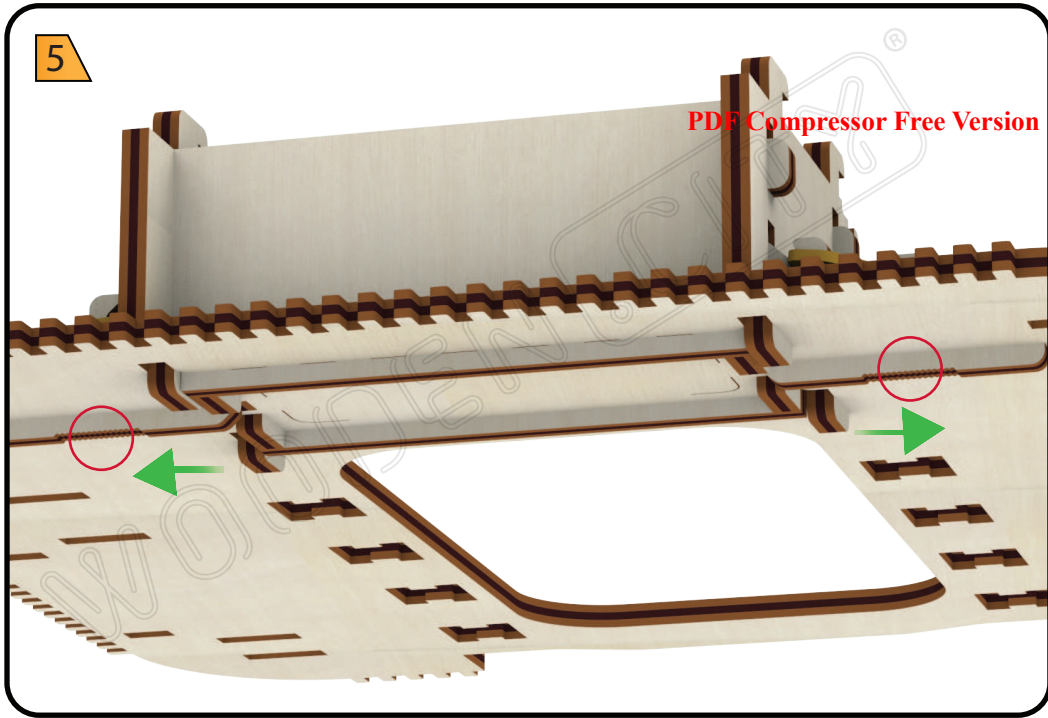

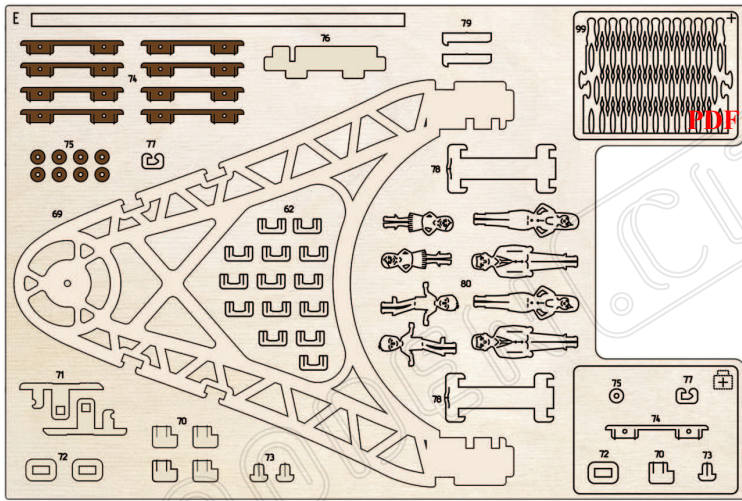

1

PDF Compressor Free Version

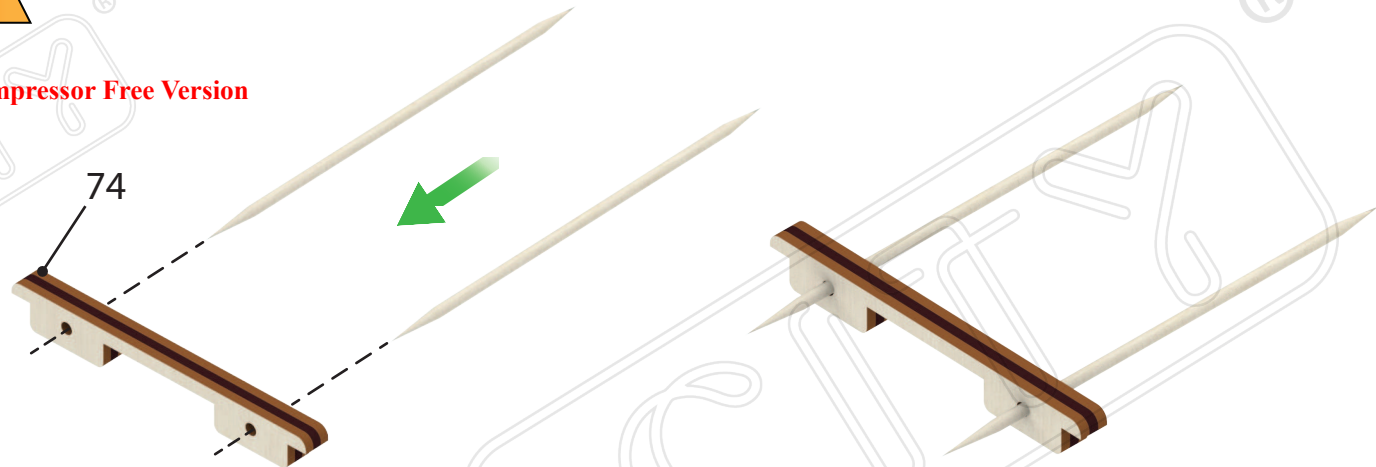

2

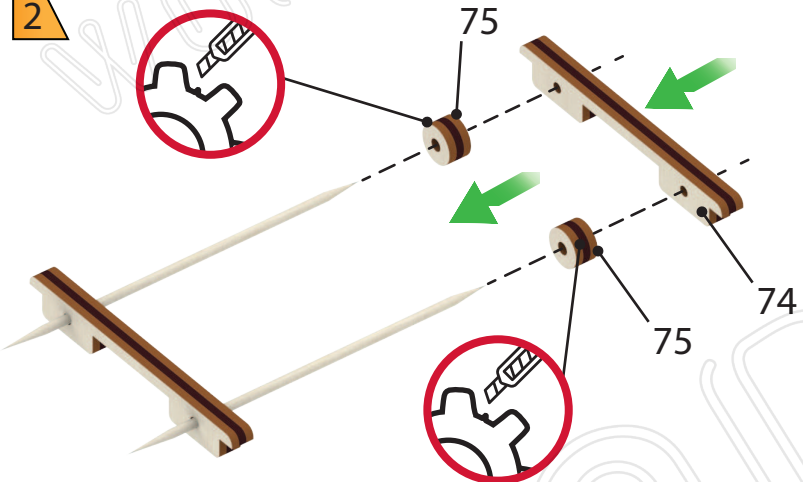

3

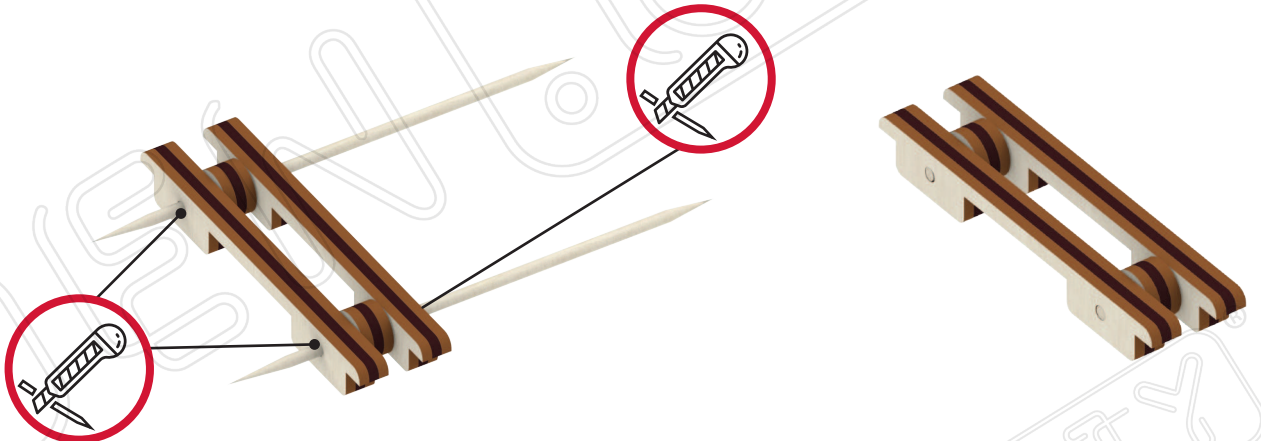

4

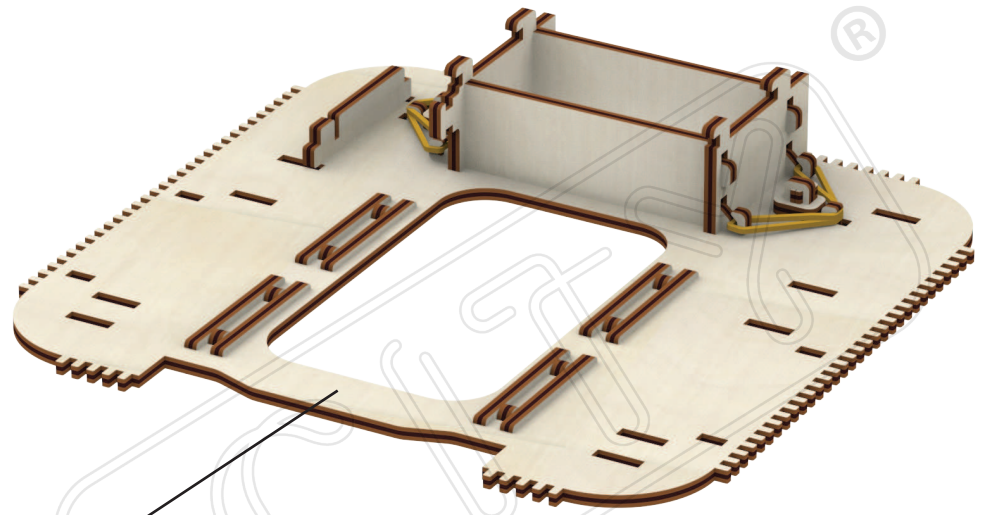
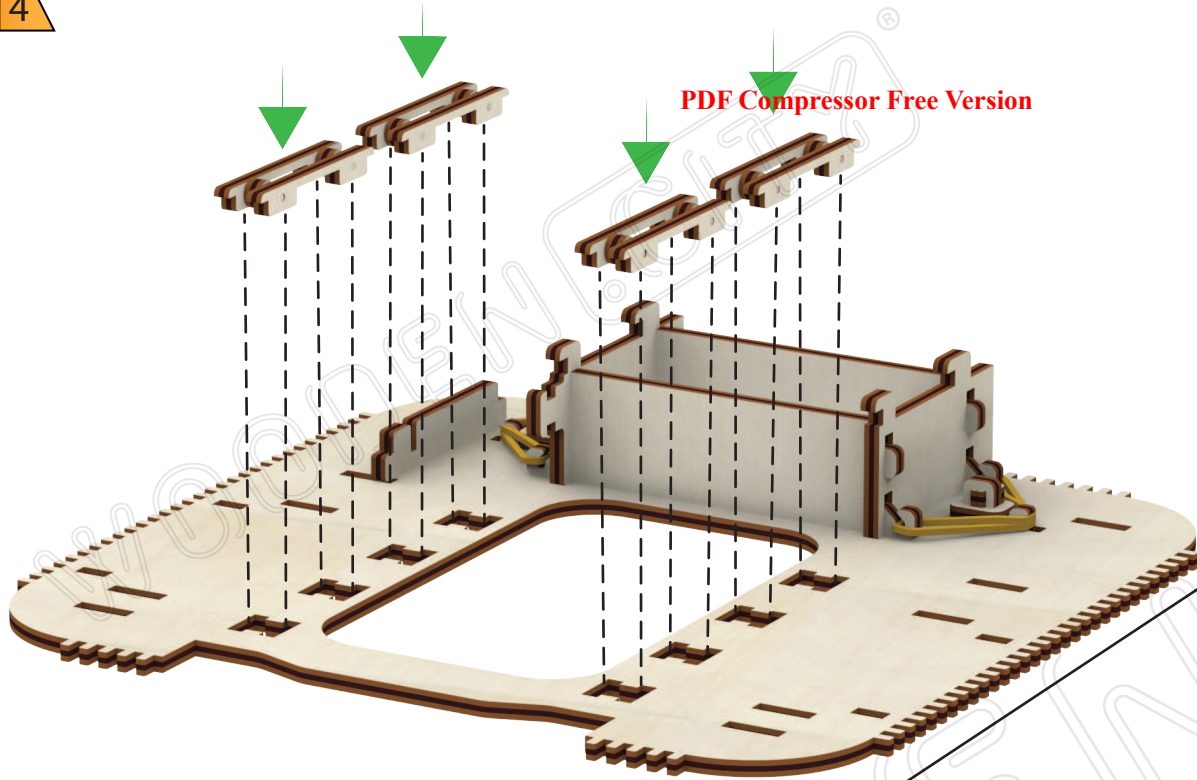

5

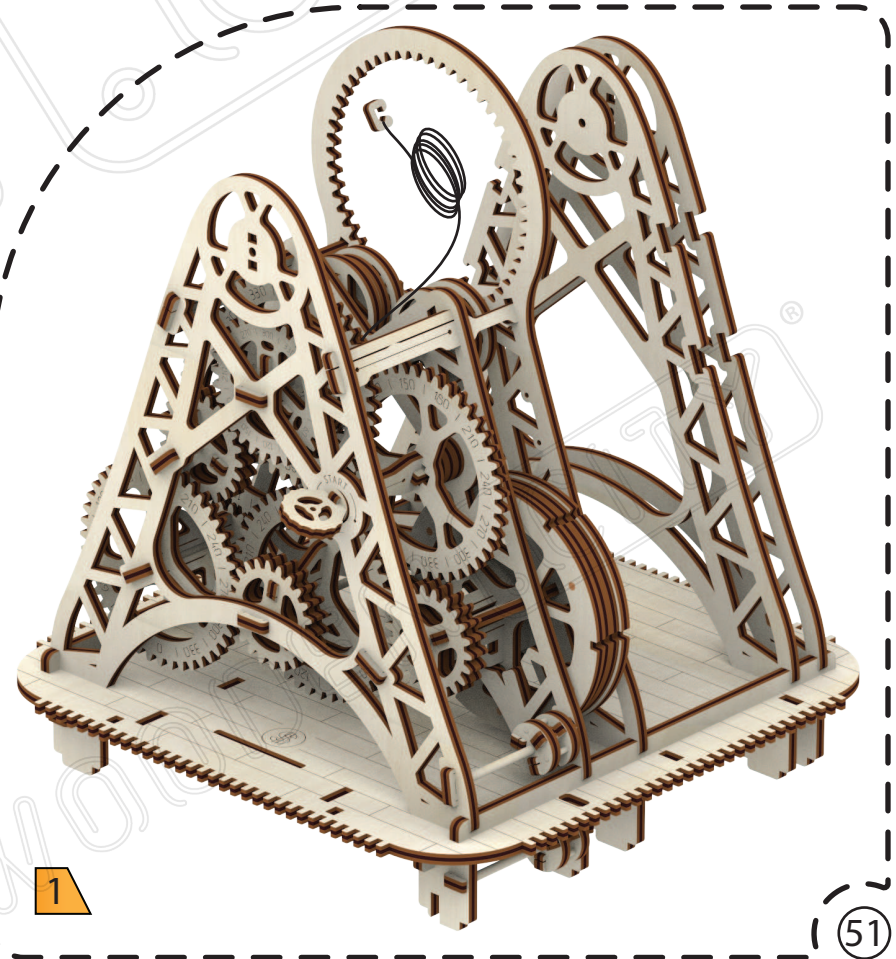
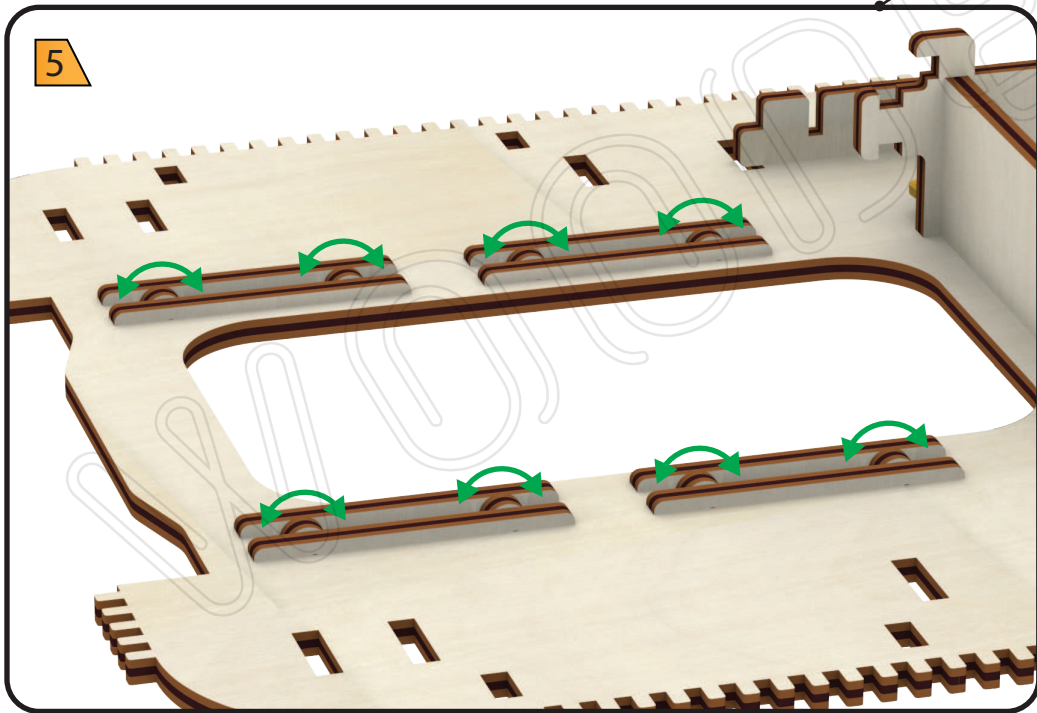

PDF Compressor Free Version

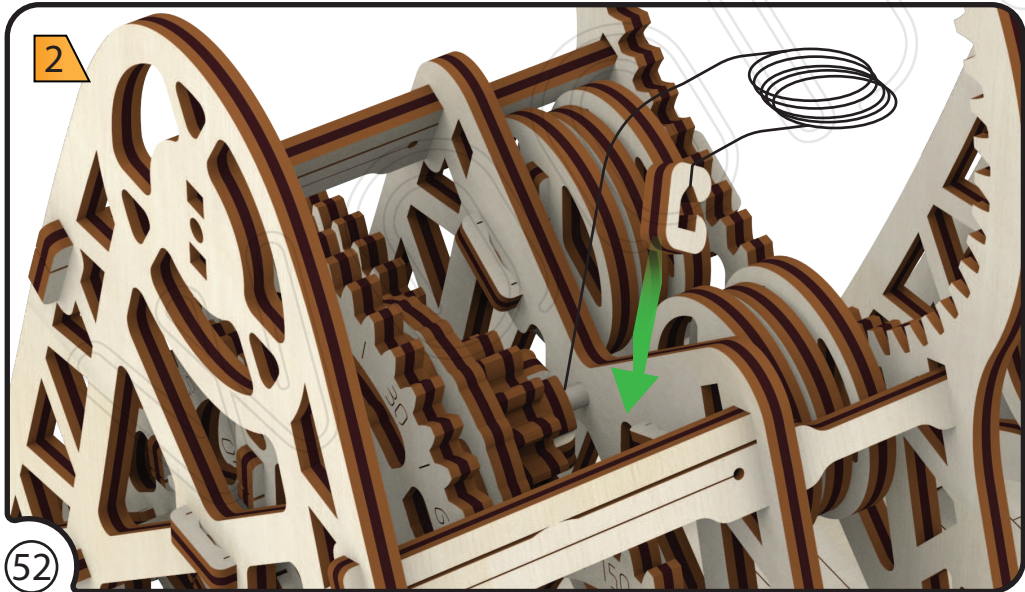
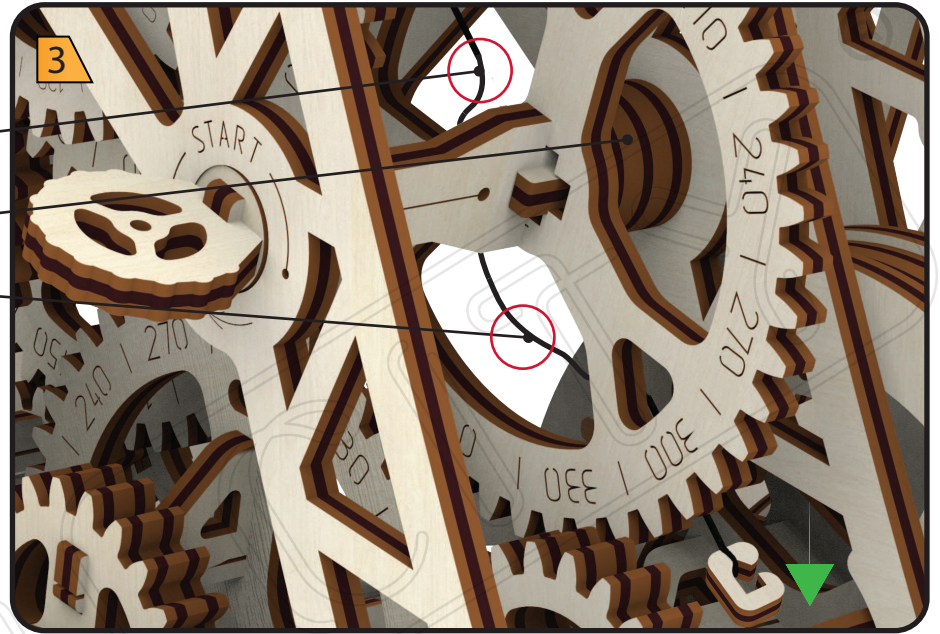
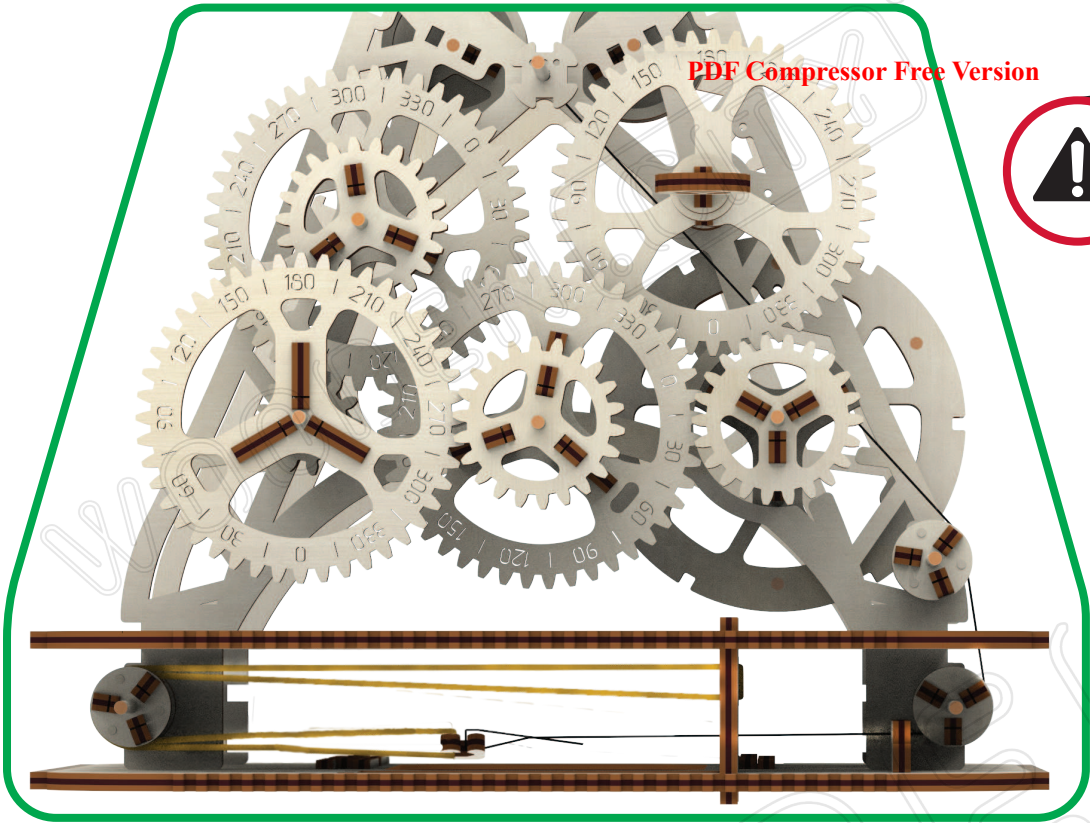



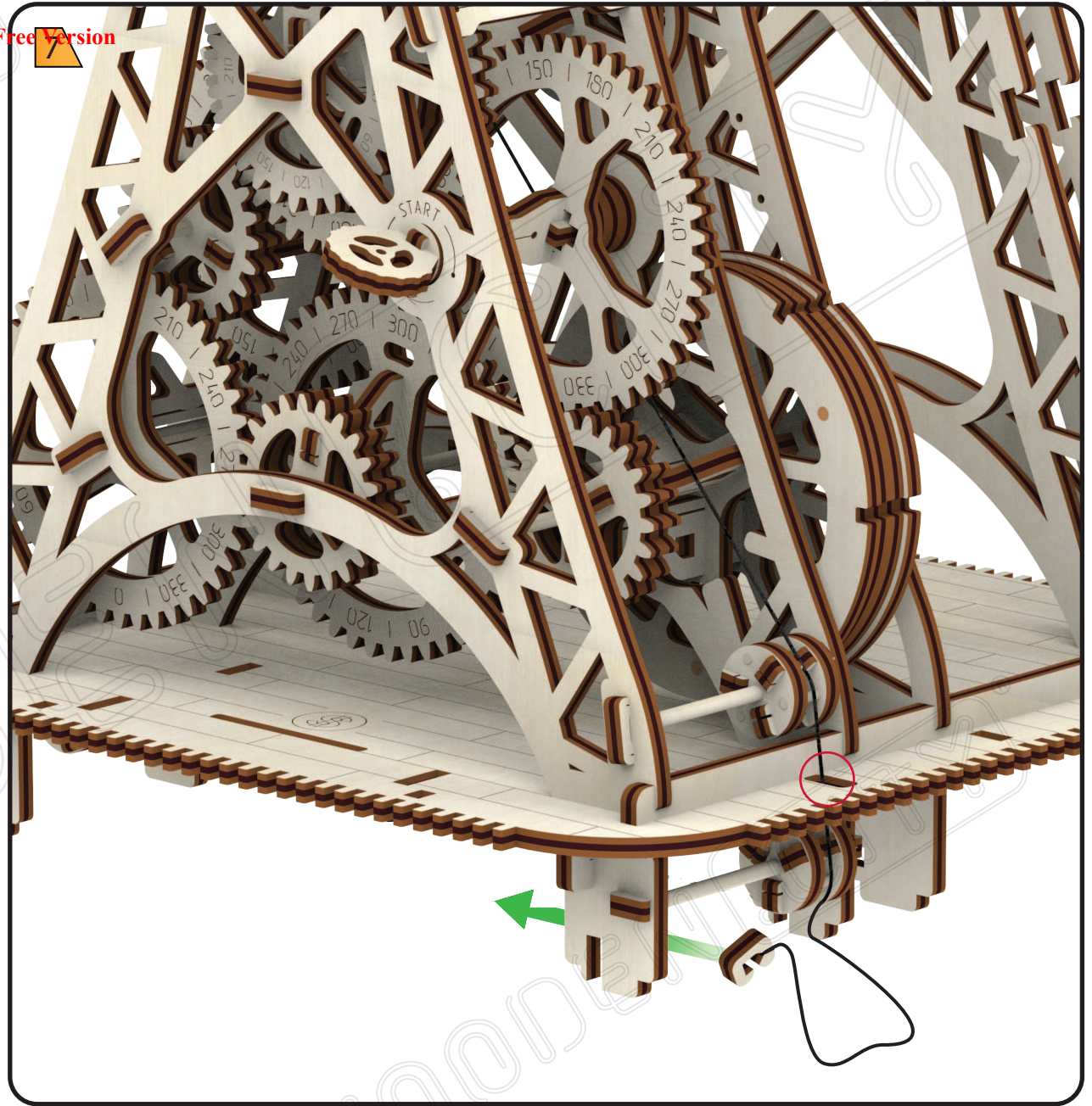
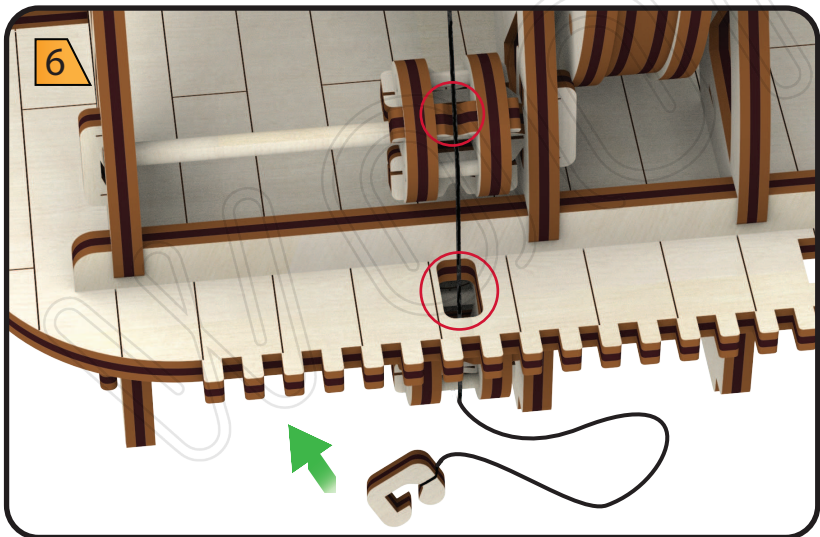
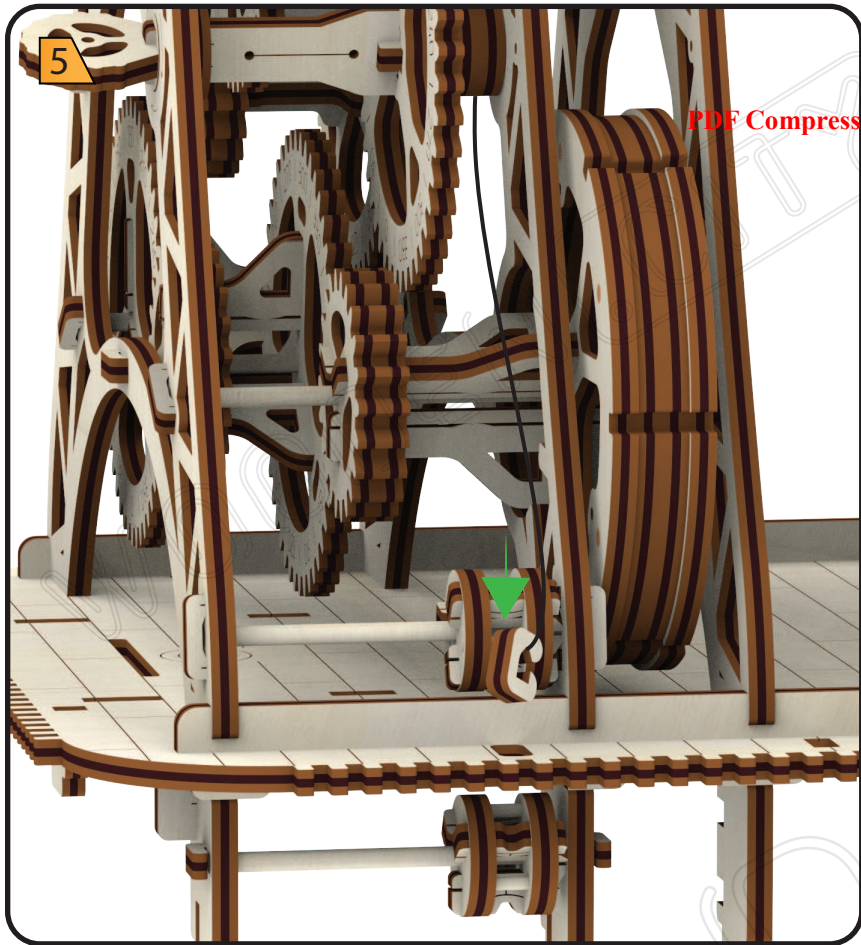

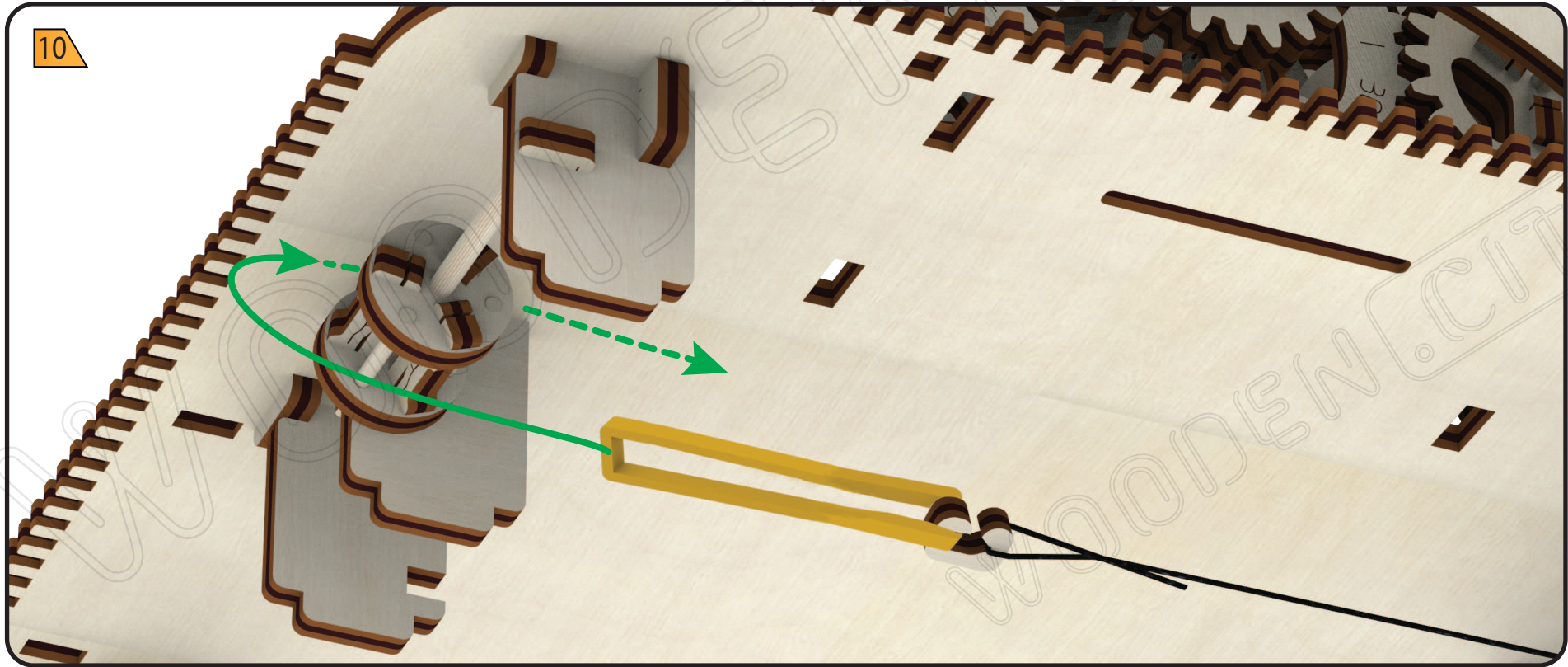
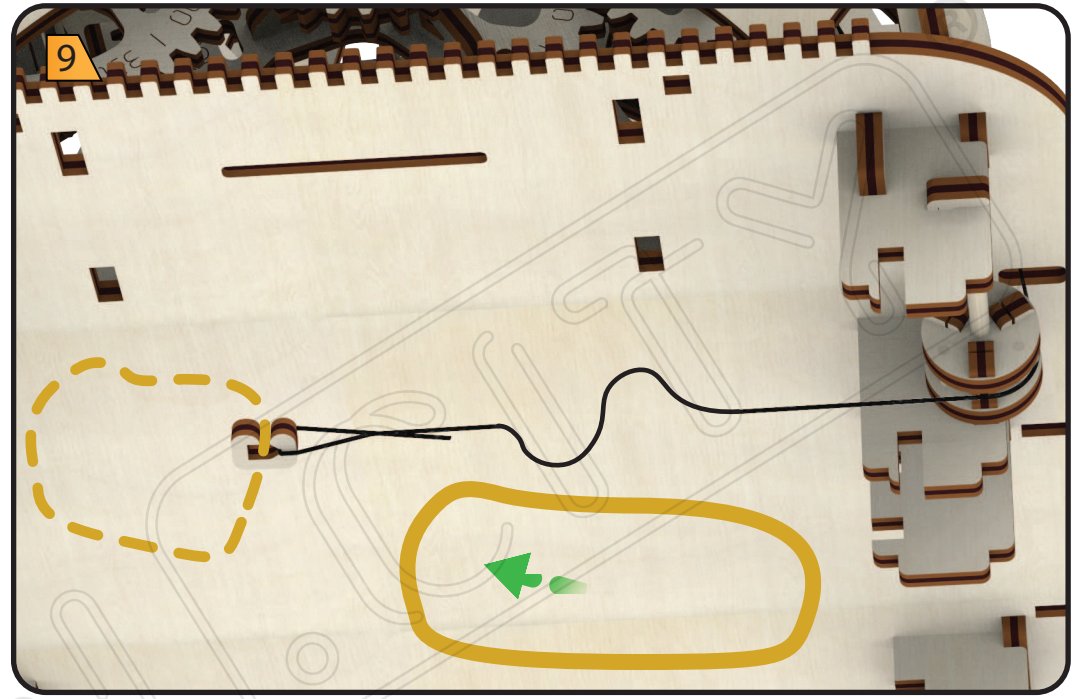
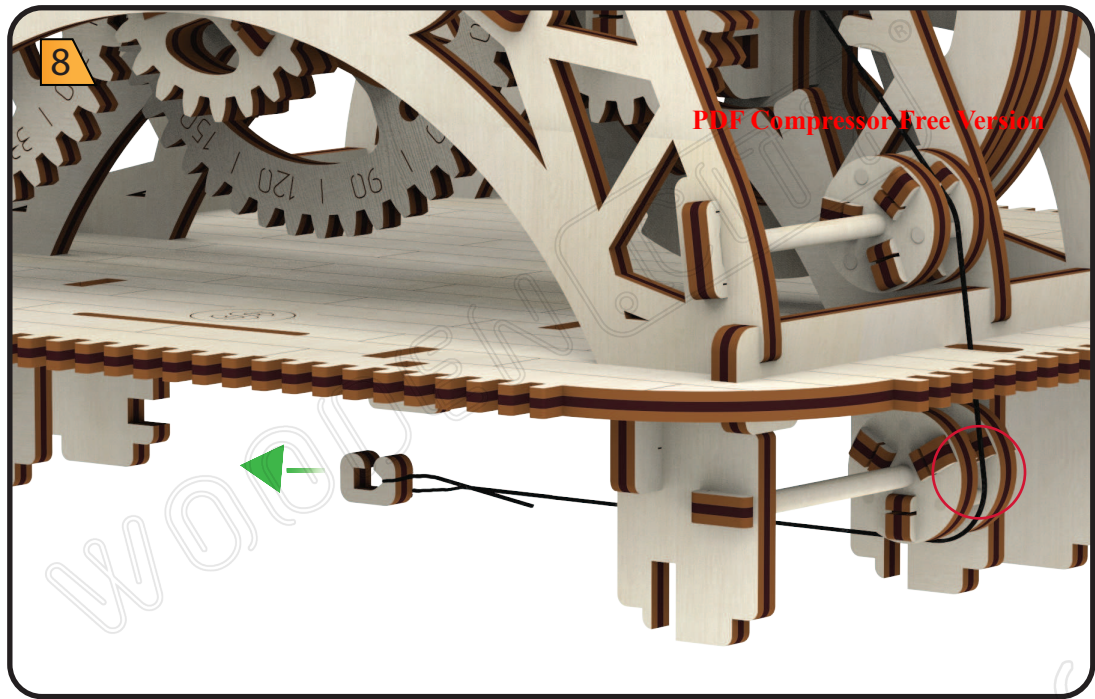

PDF Compressor Free Version

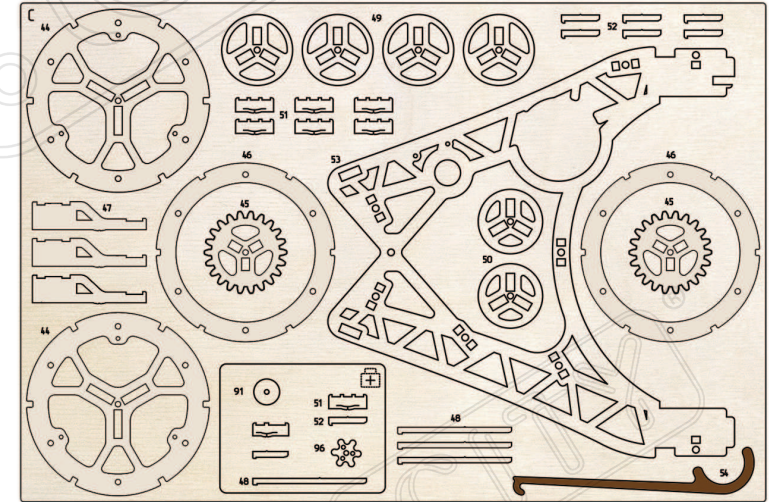
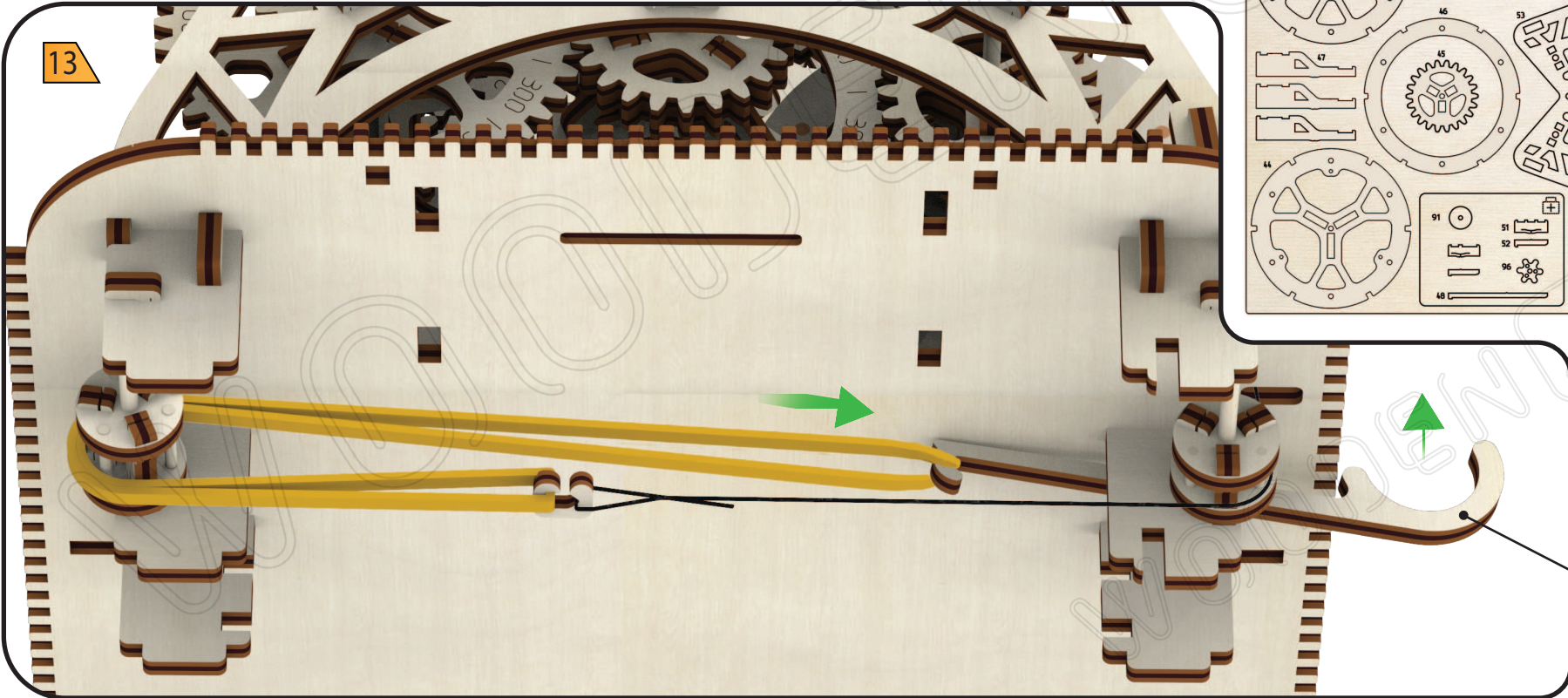
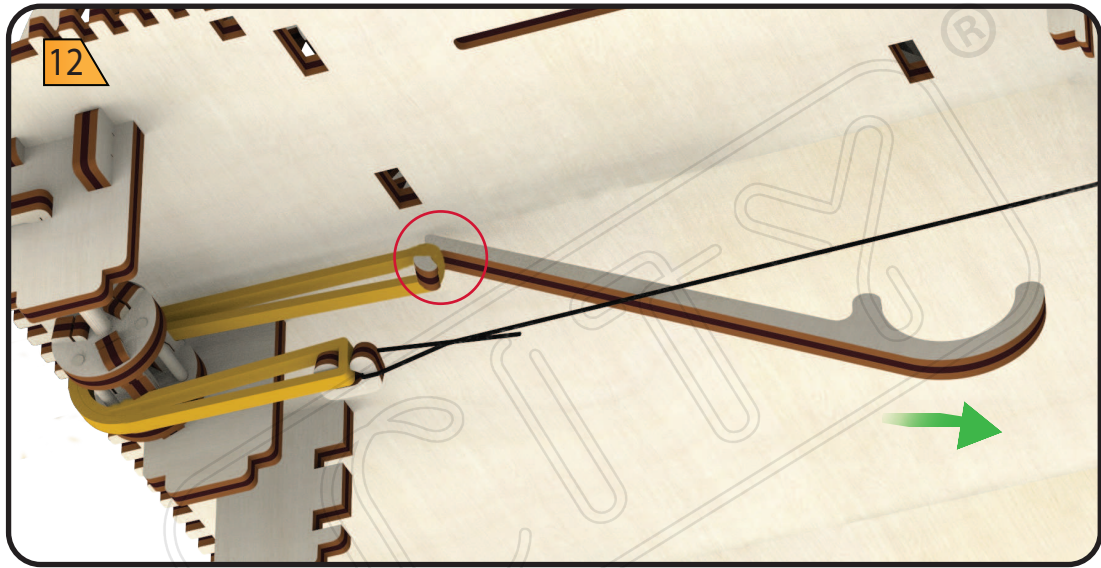
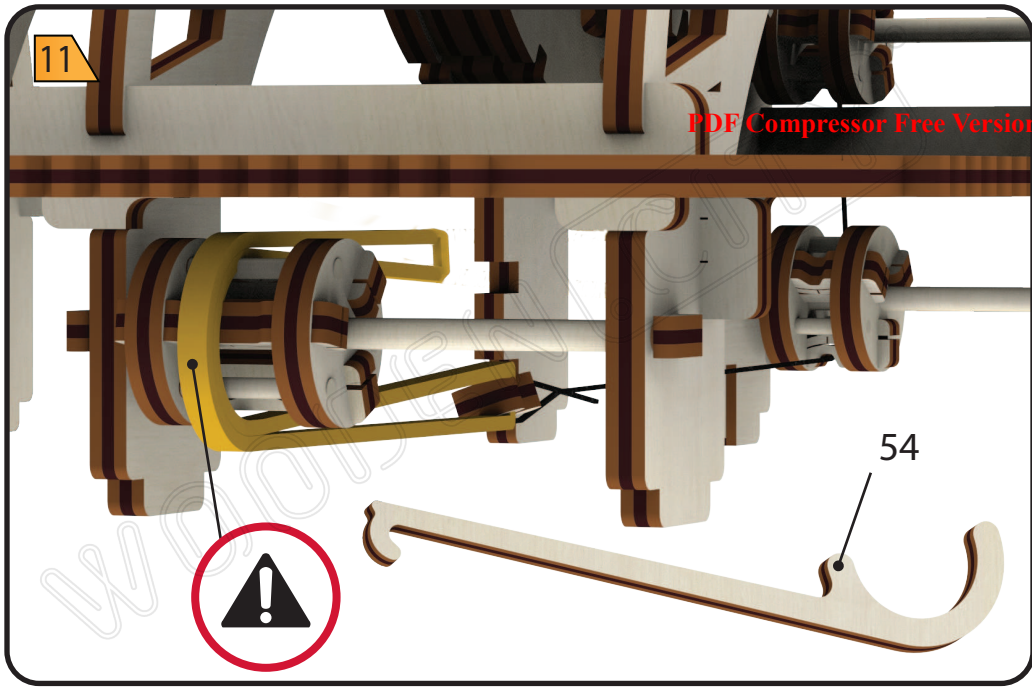

14

PDF Compressor Free Version

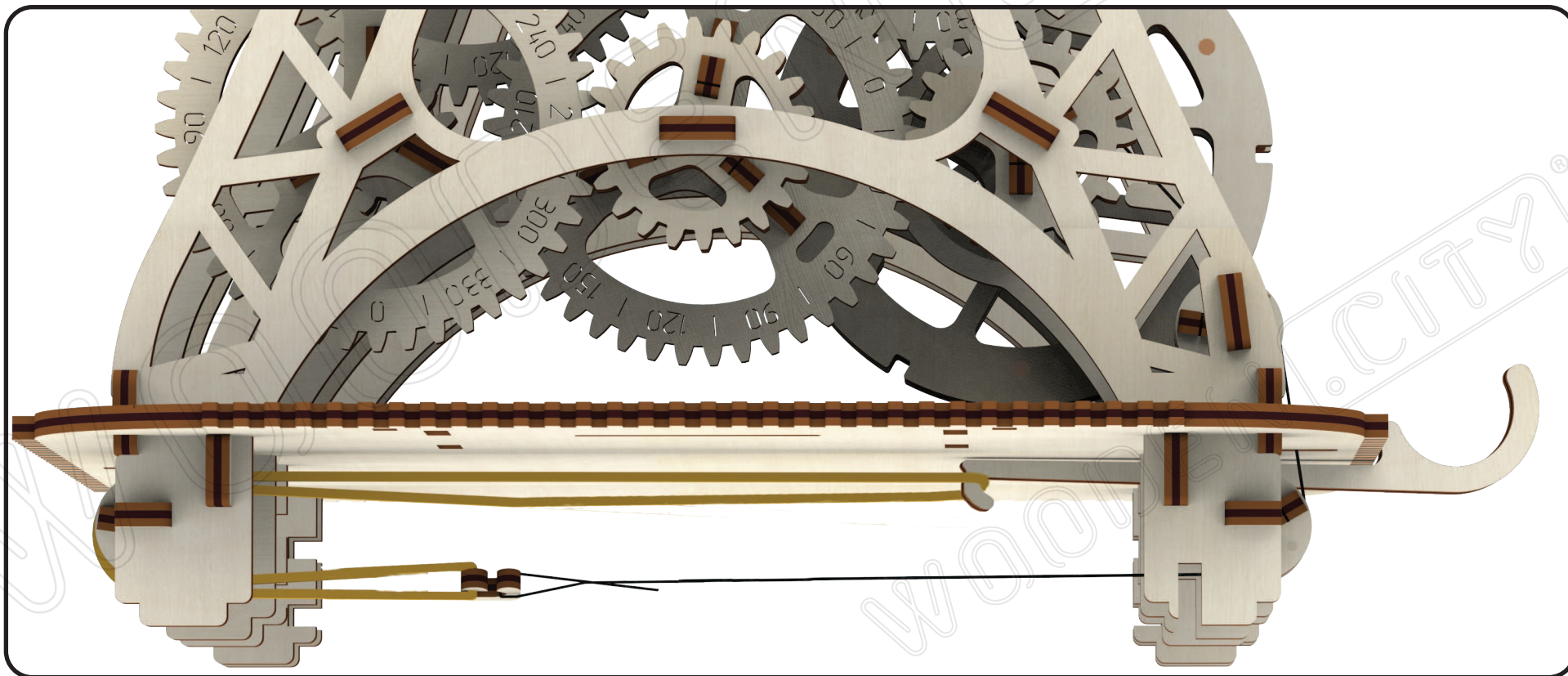
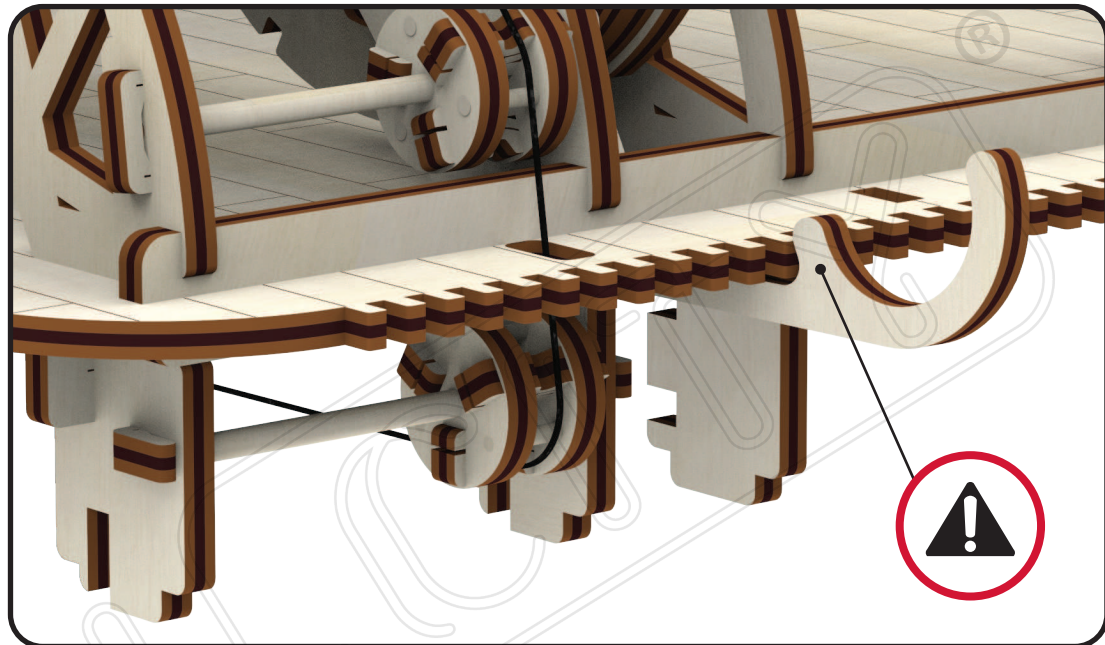
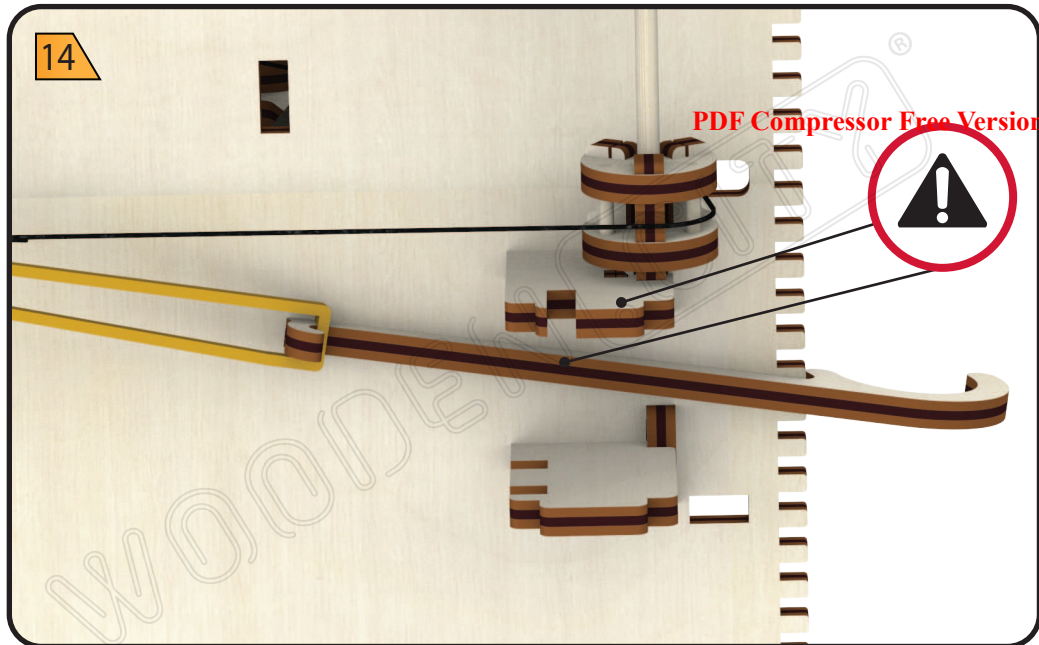

56

1

PDF Compressor Free Version

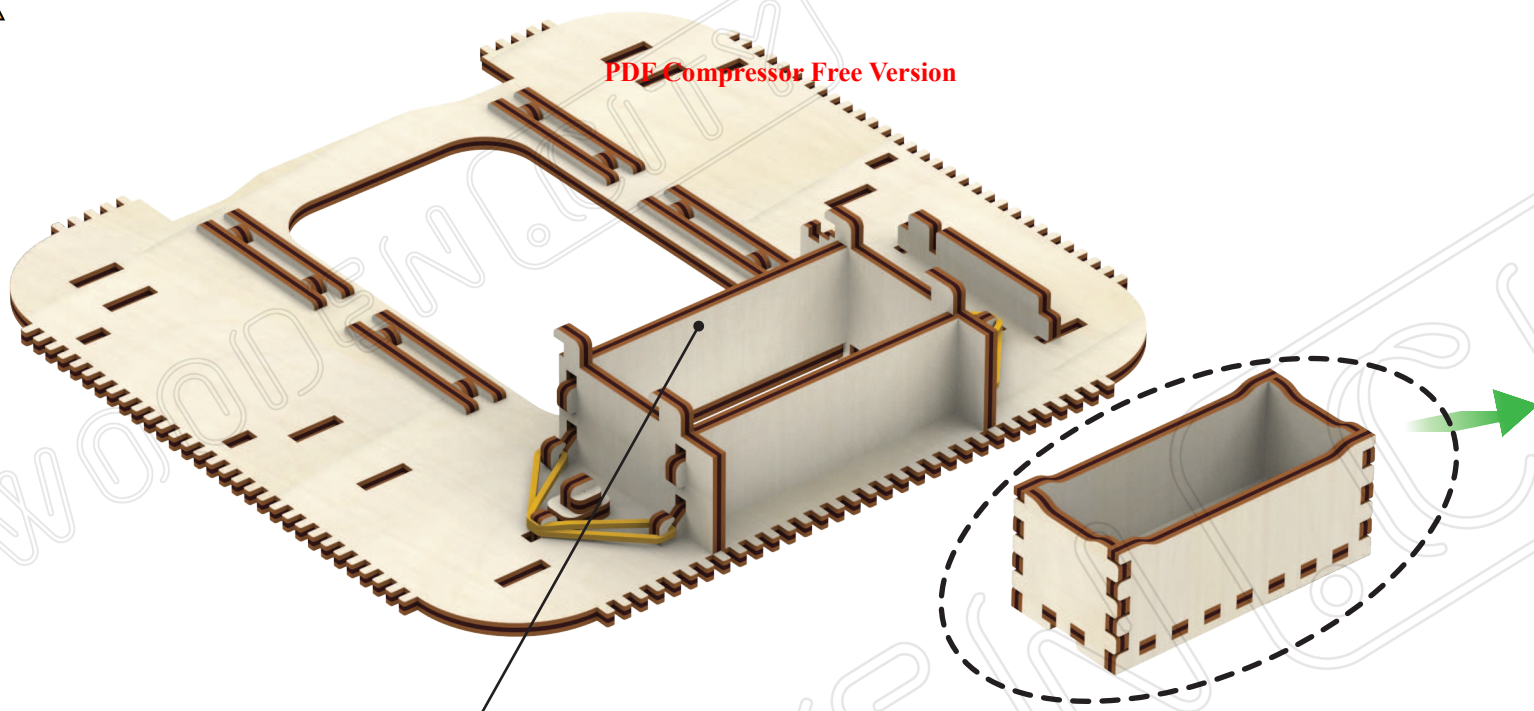

2

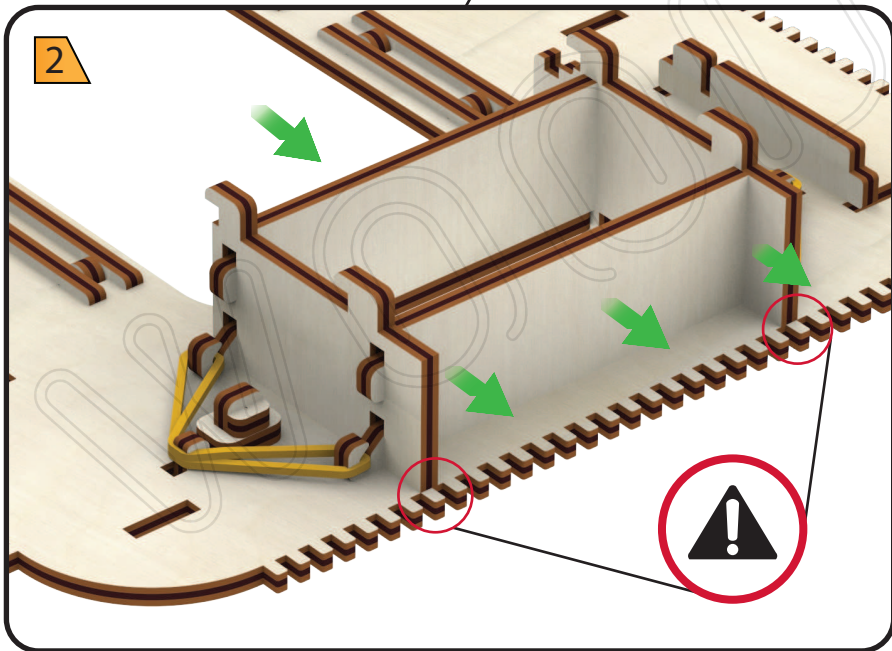

3

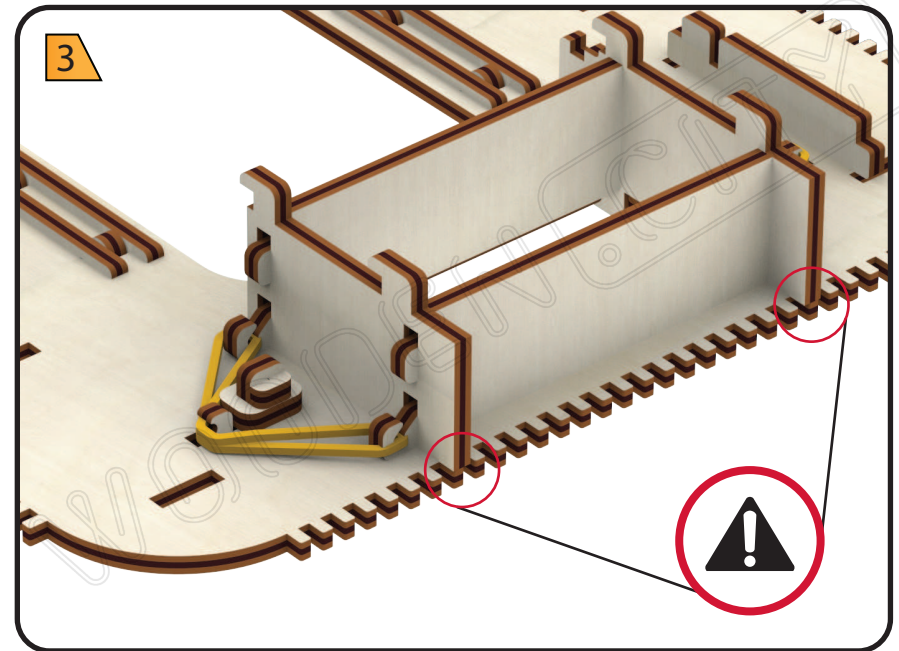

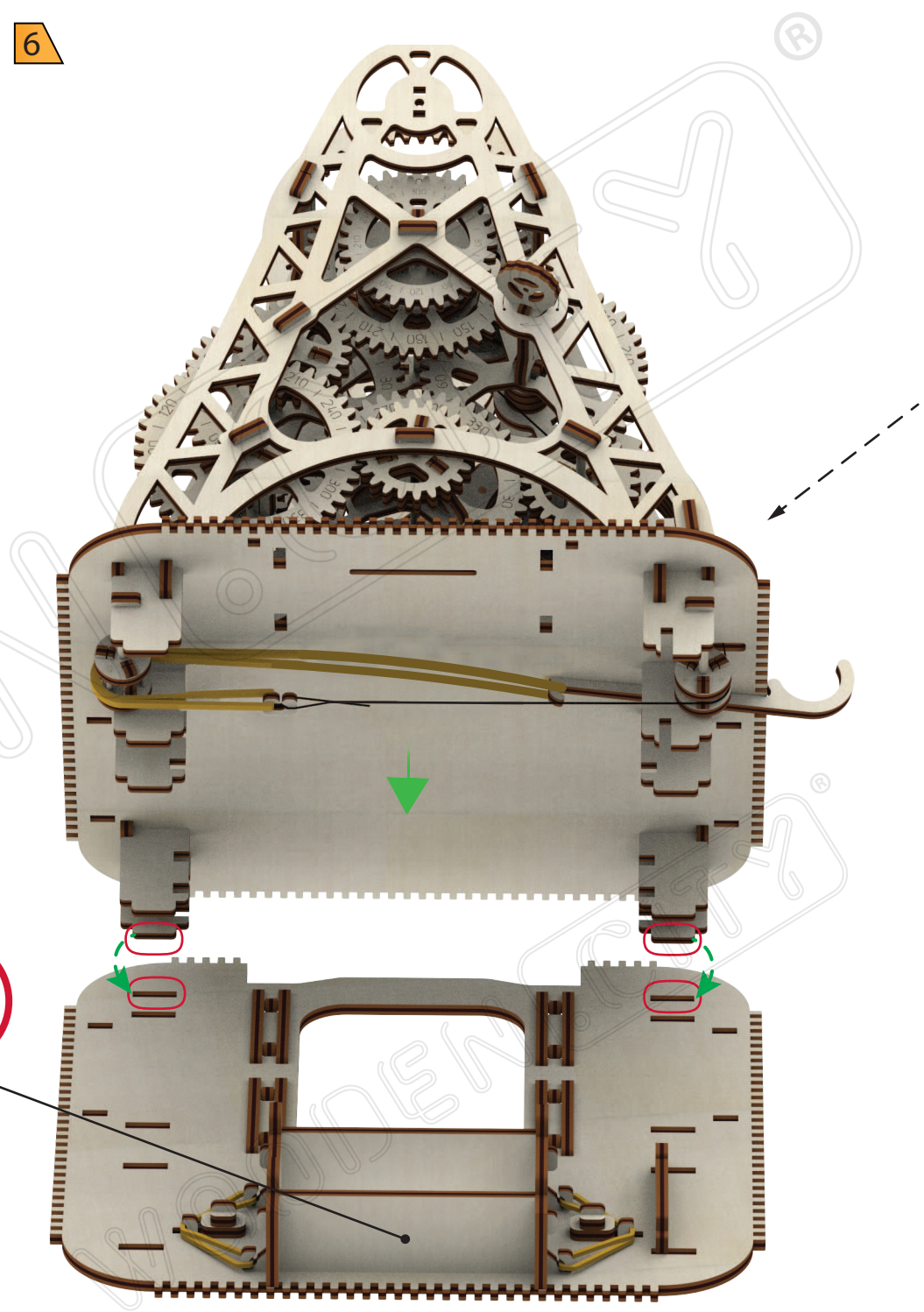
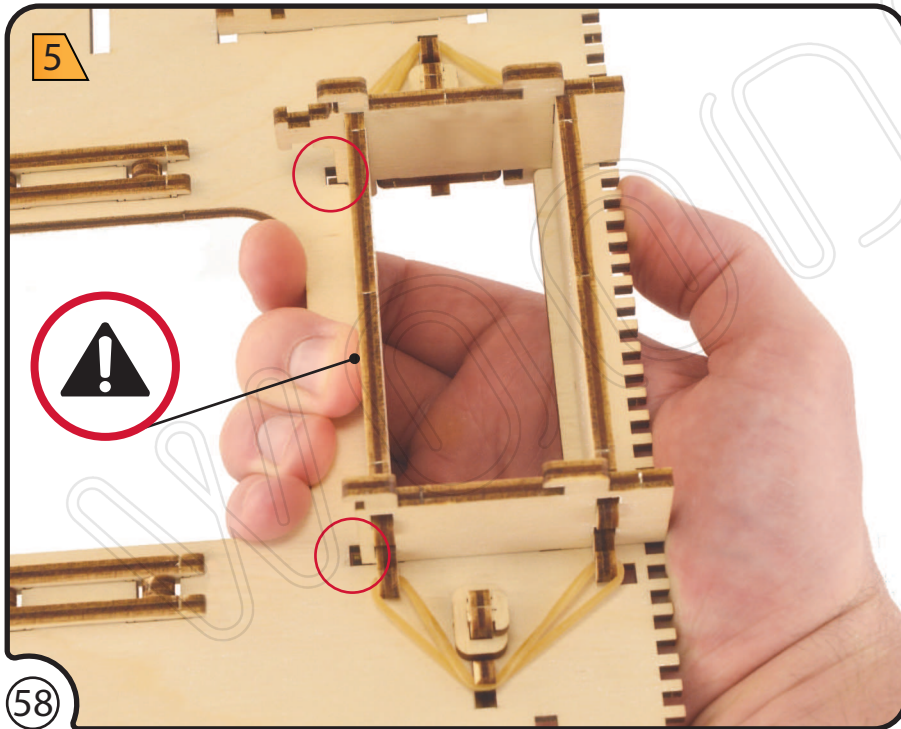
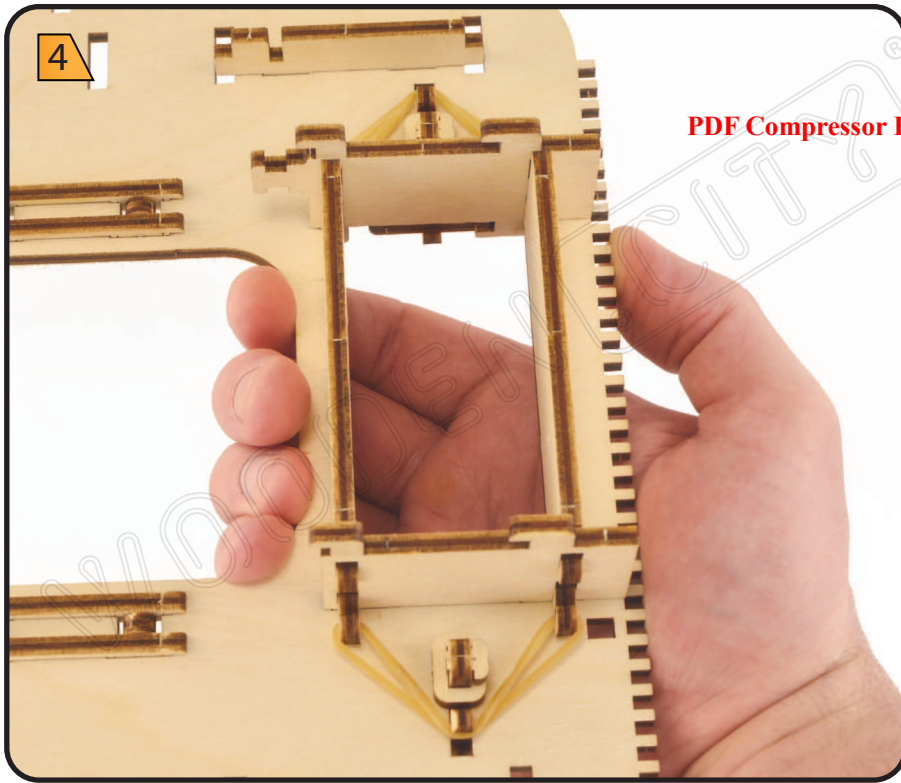

PDF Compressor Free Version

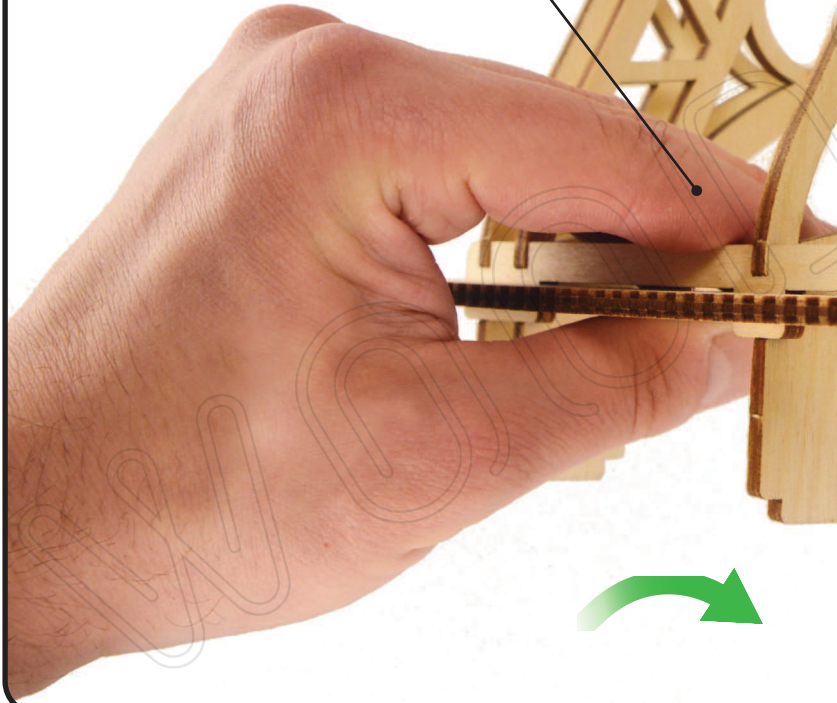

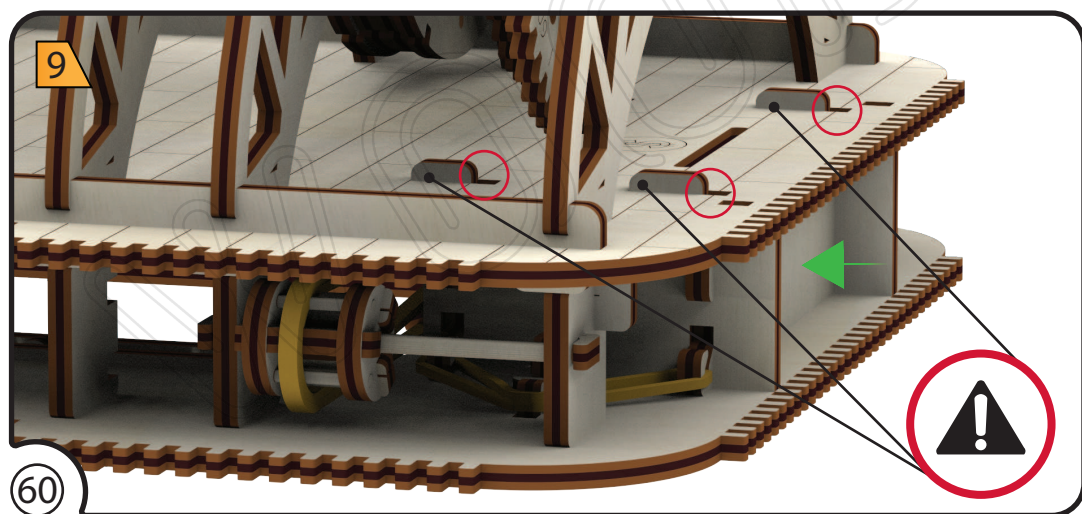
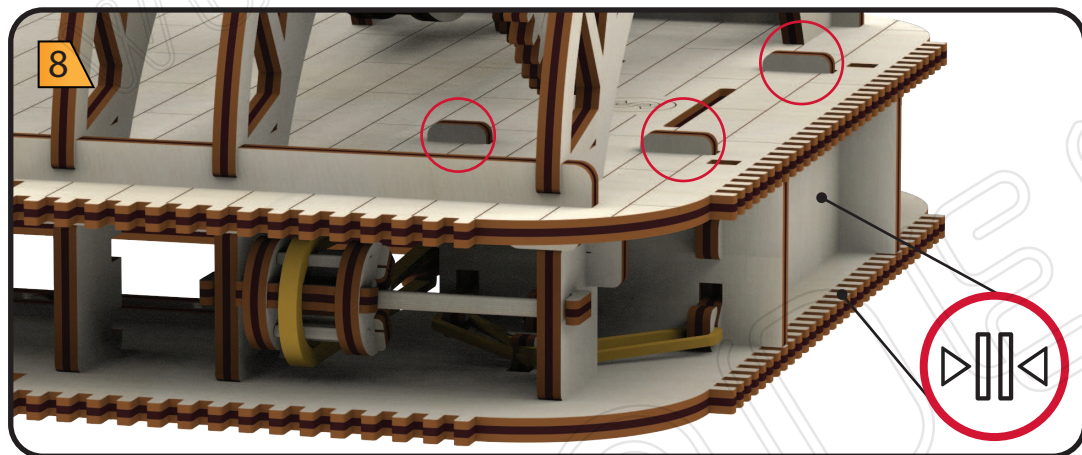
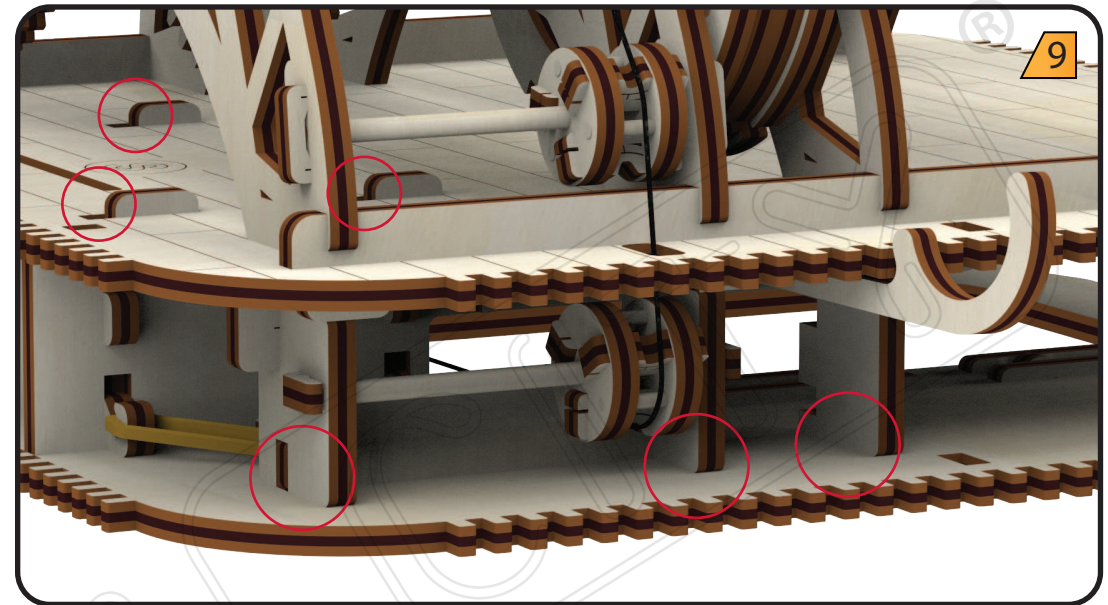
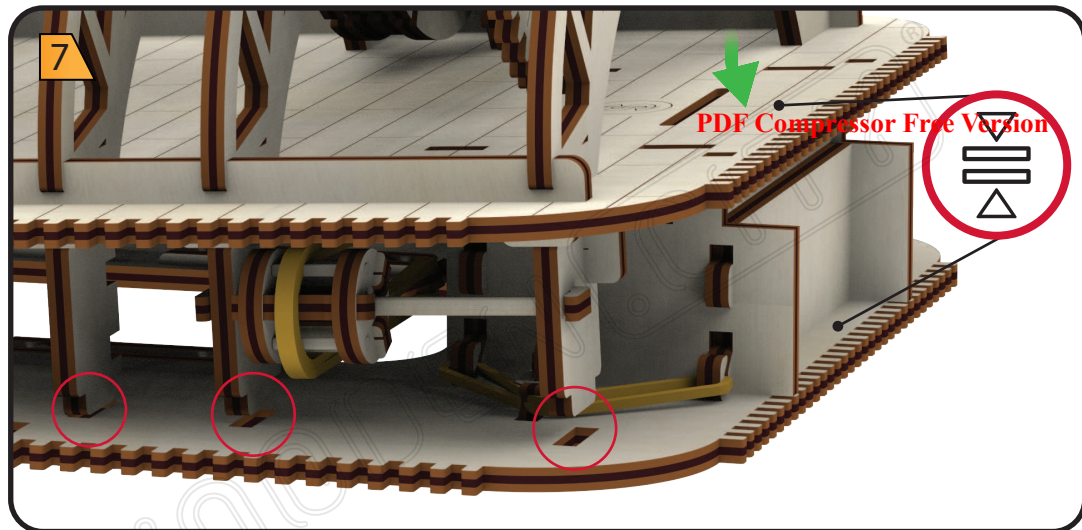

10

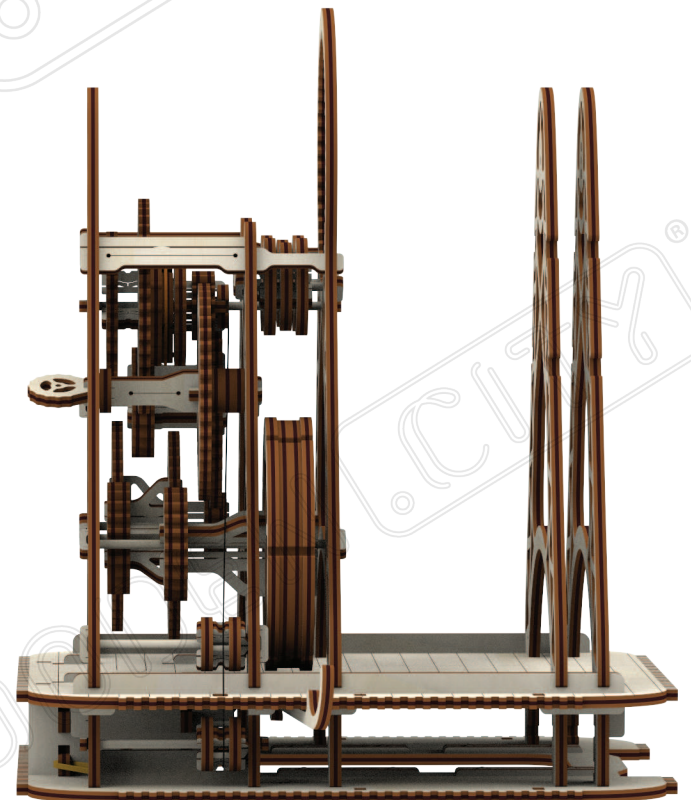



11

PDF Compressor Free Version

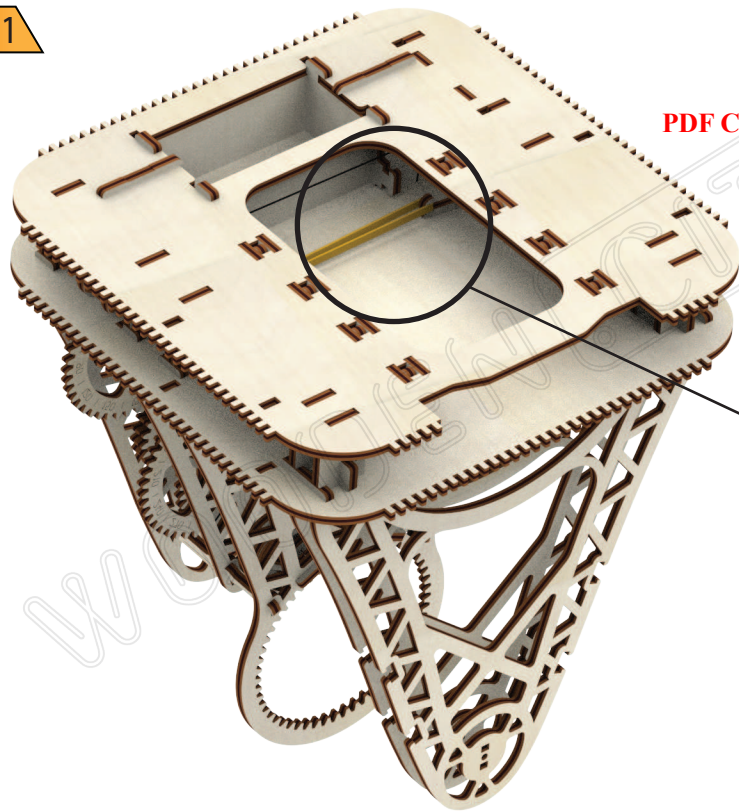

12

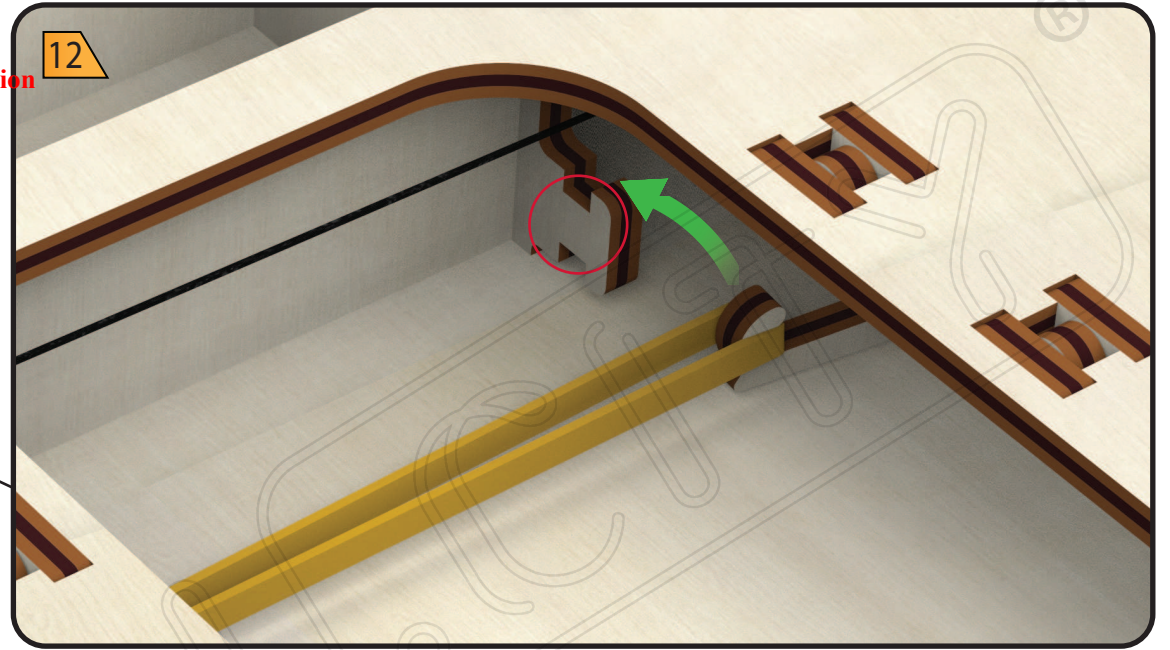

13

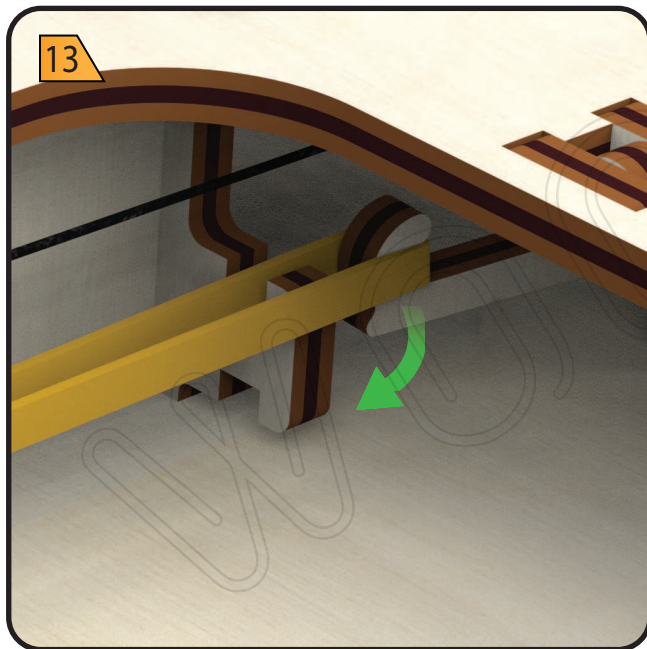

14

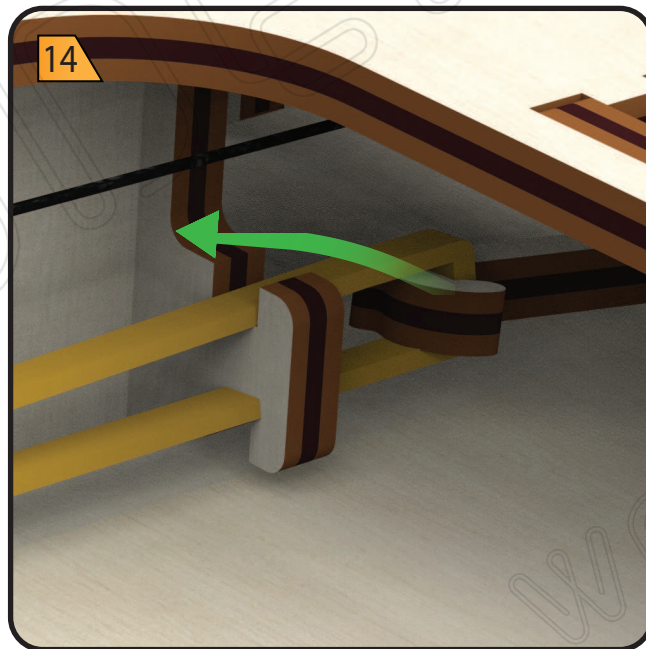

15

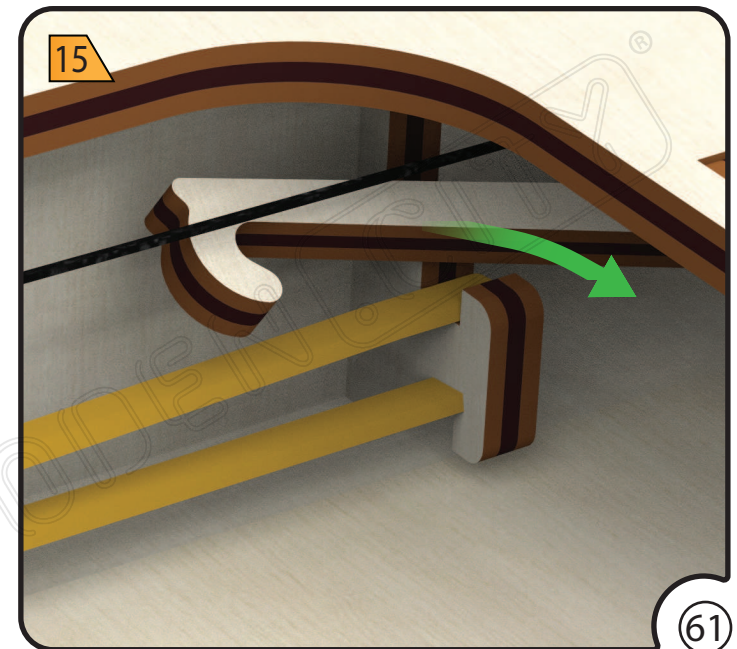

16



PDF Compressor Free Version

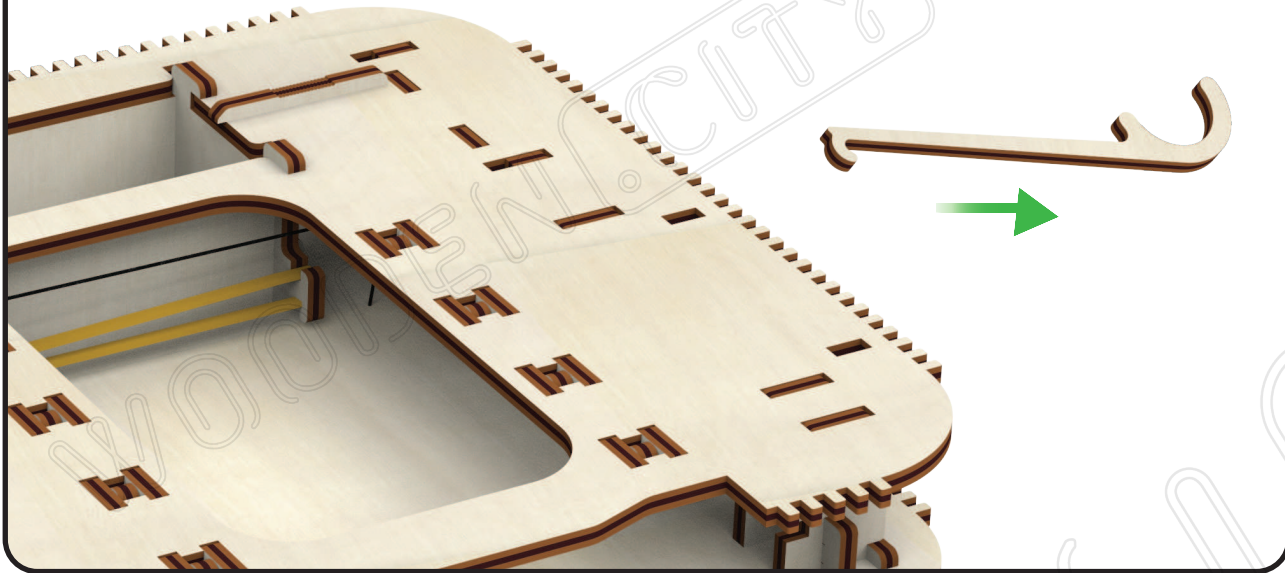

17

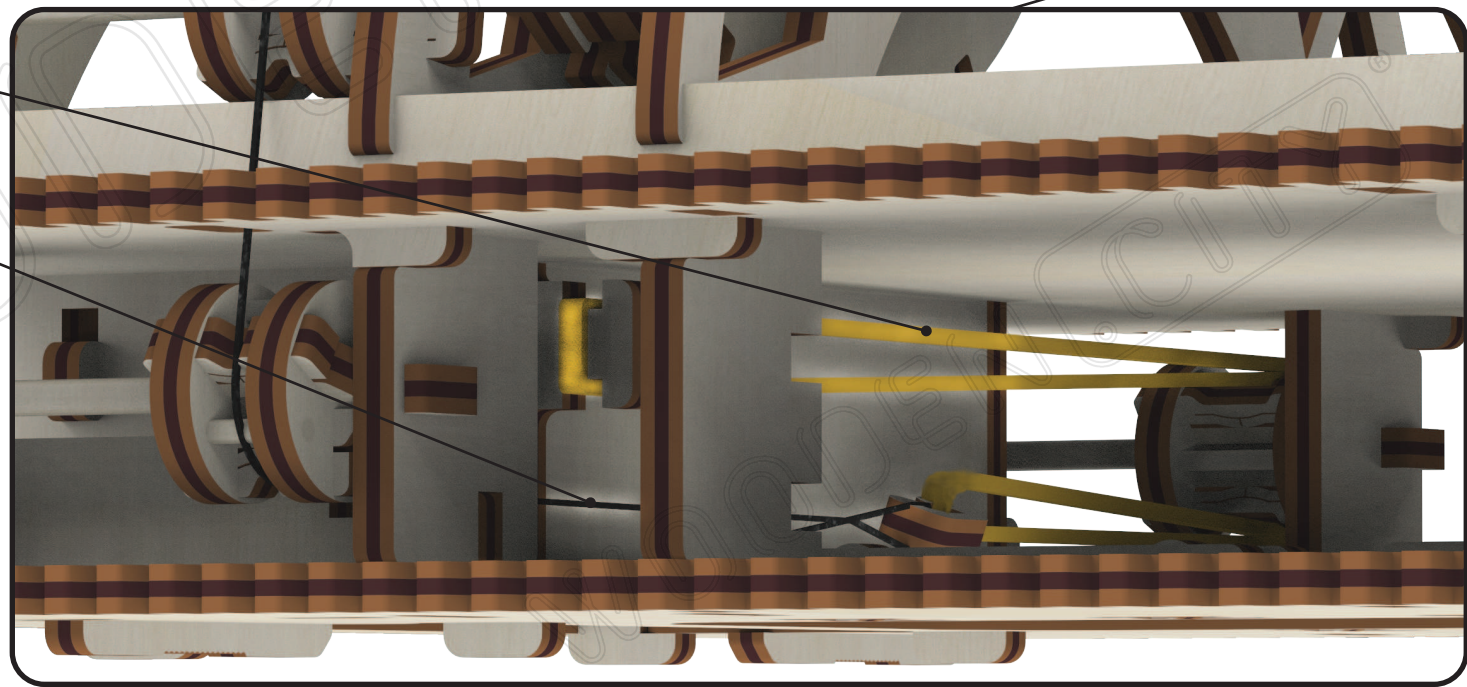
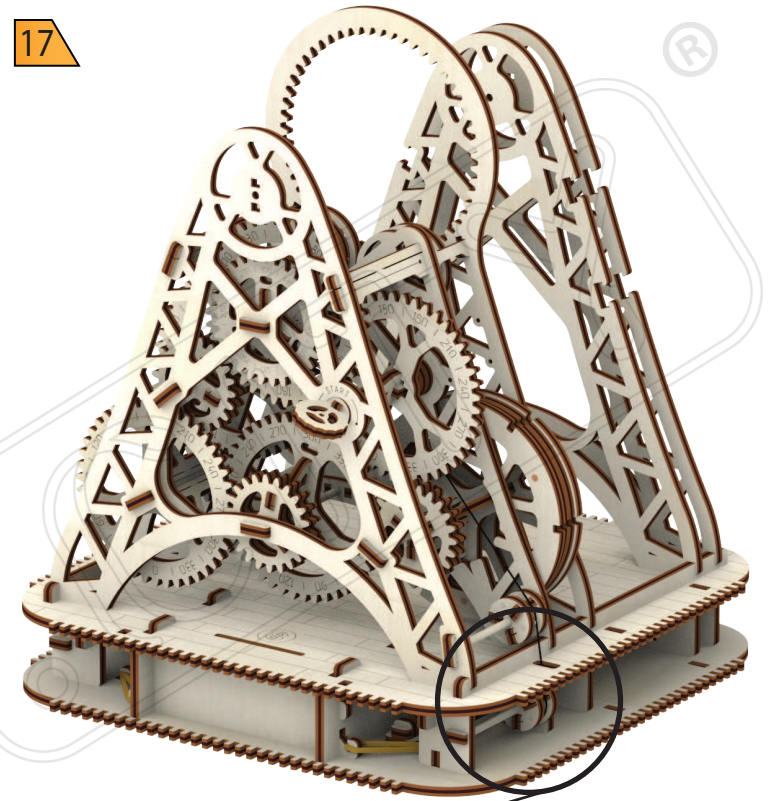

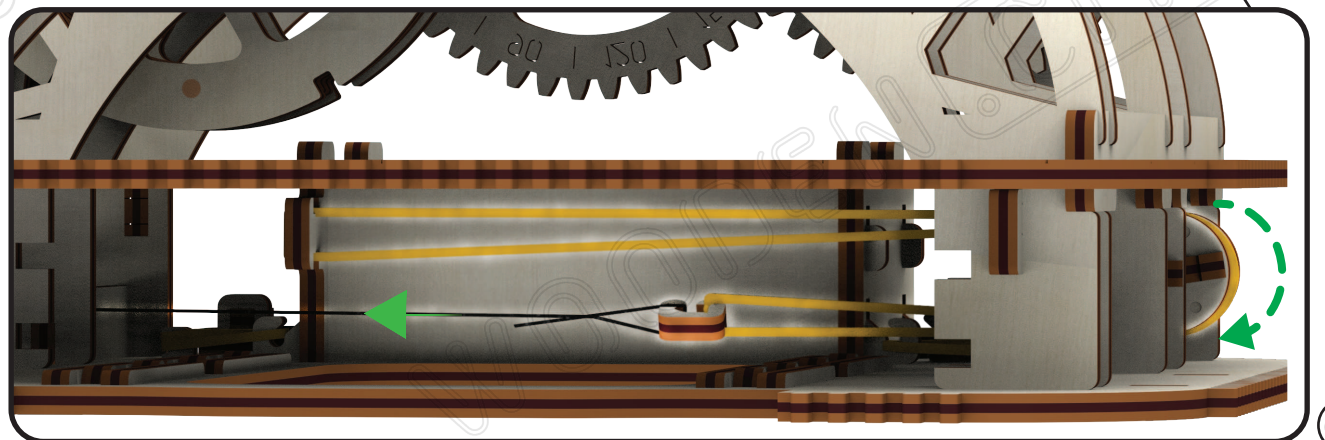
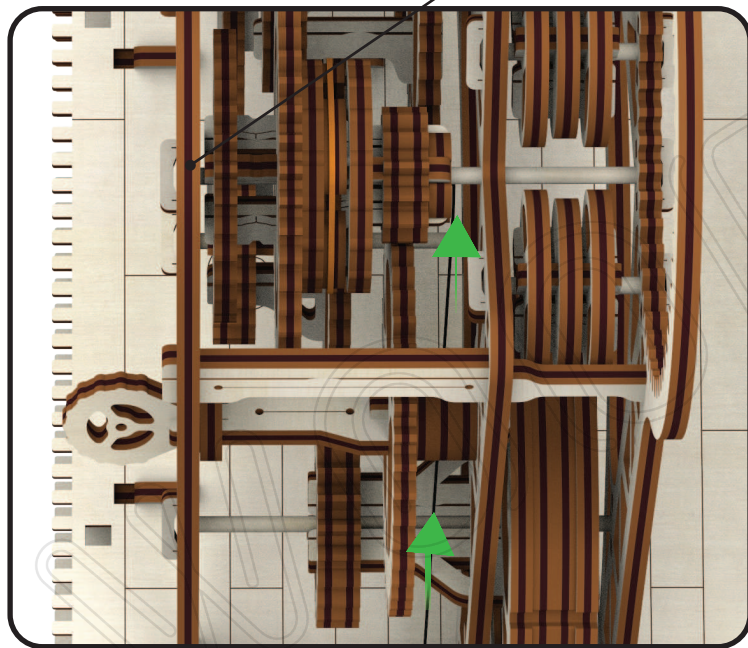
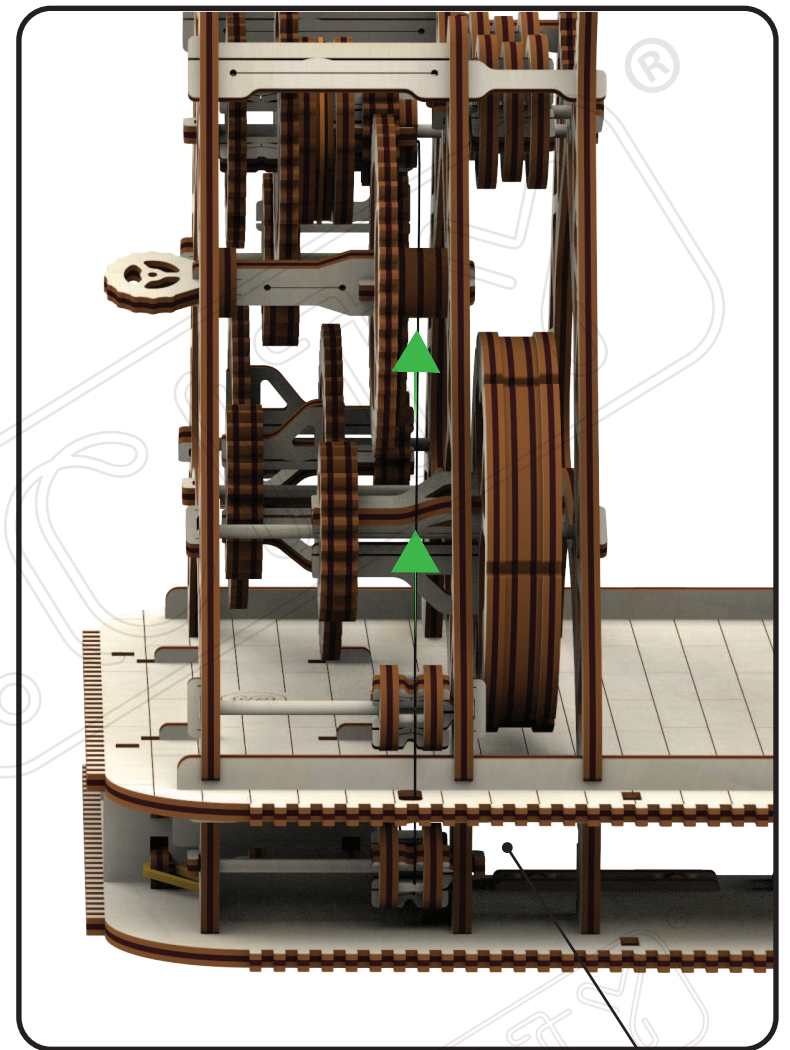
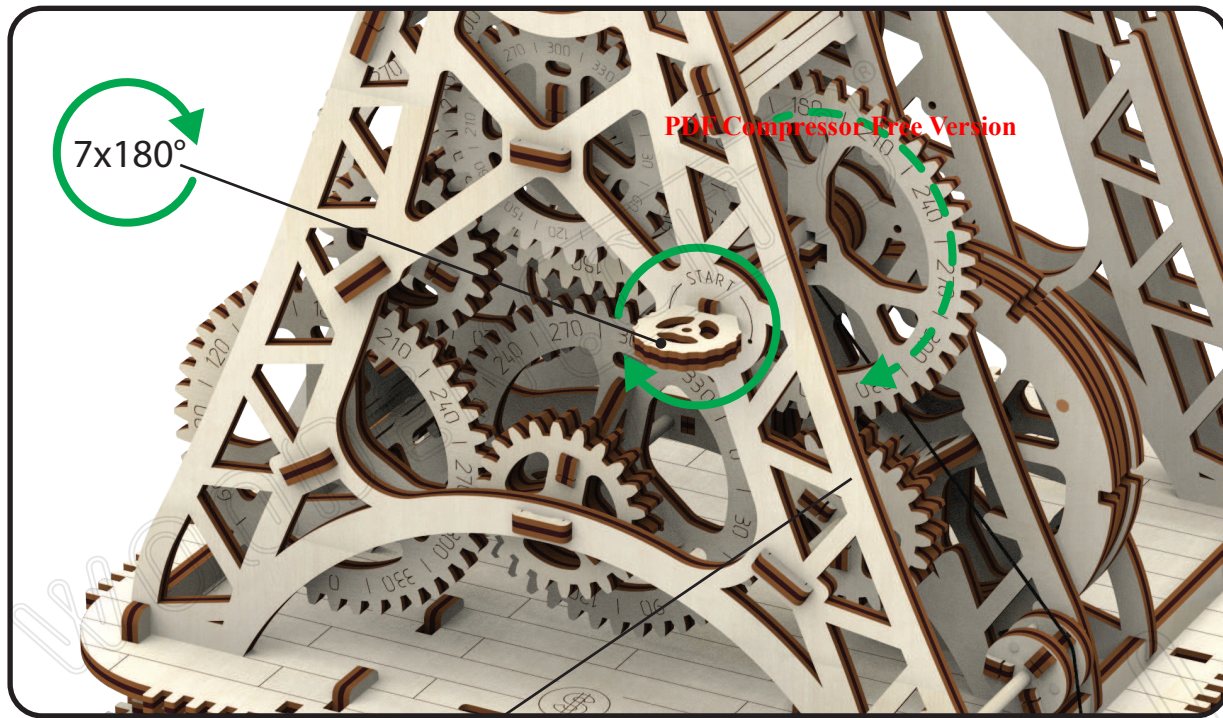

2

PDF Compressor Free Version

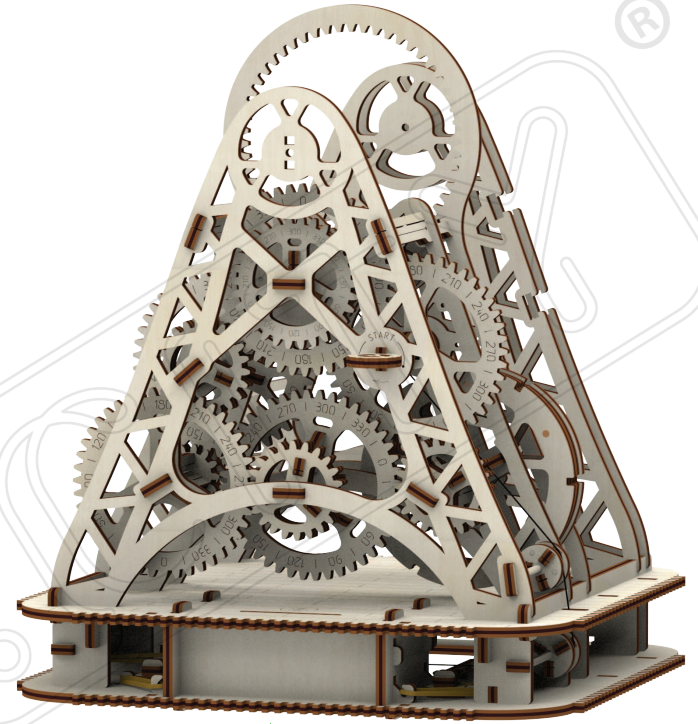
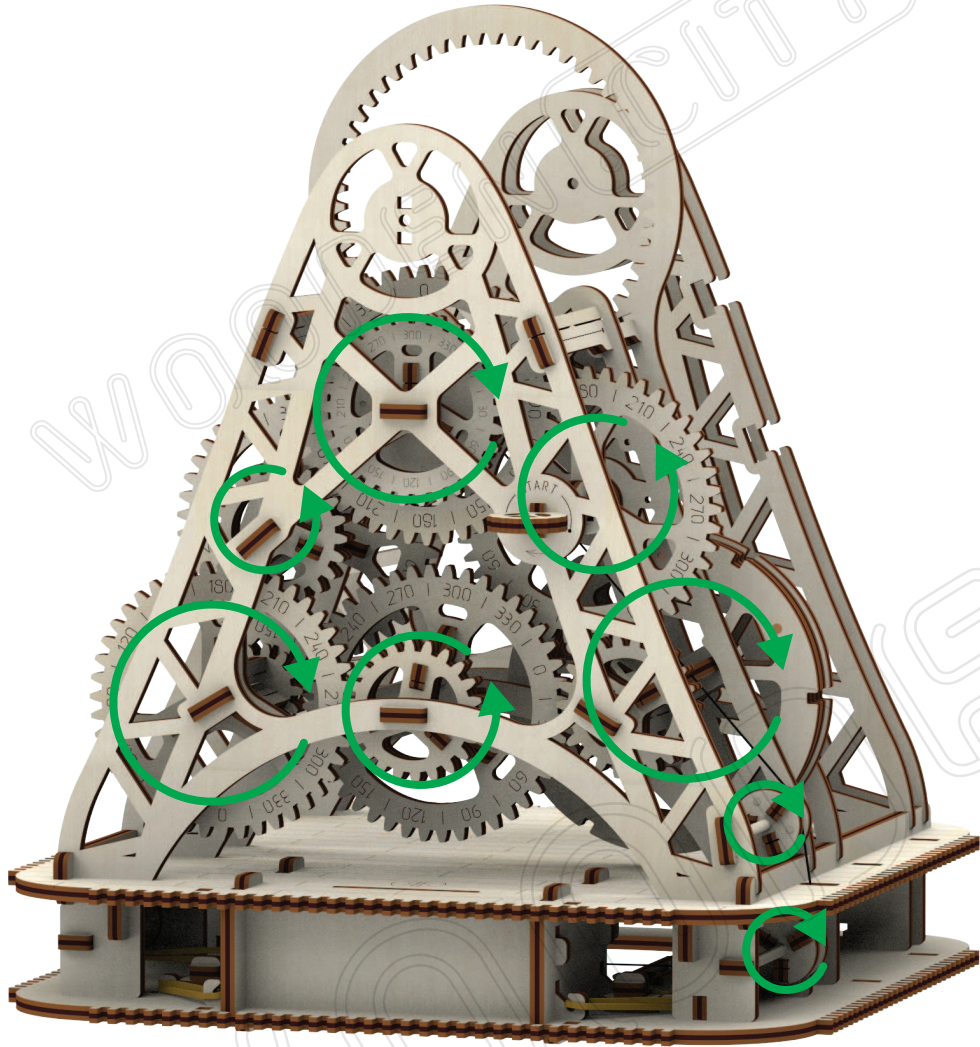

1

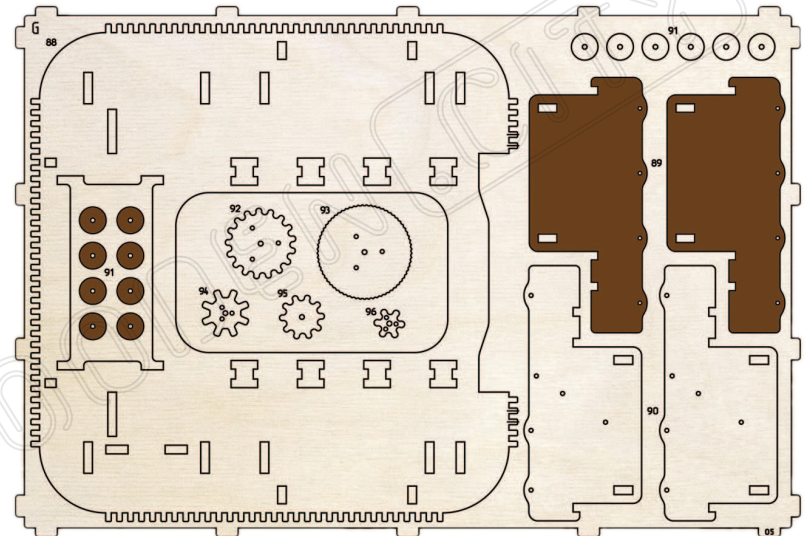

2

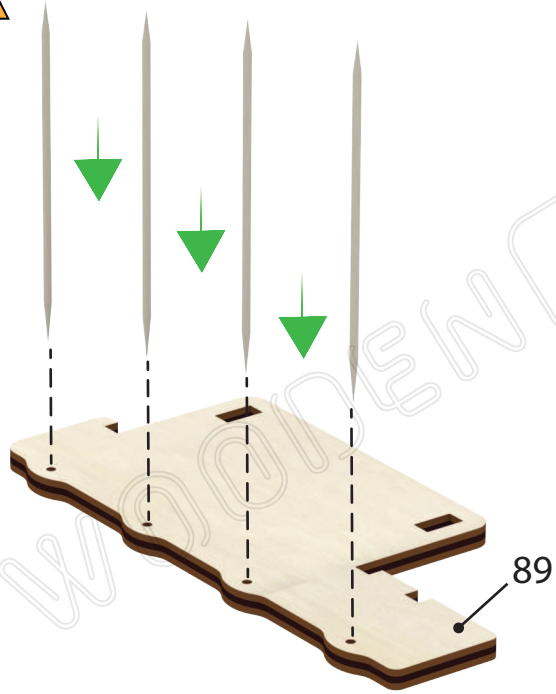

3

PDF Compressor Free Version



4

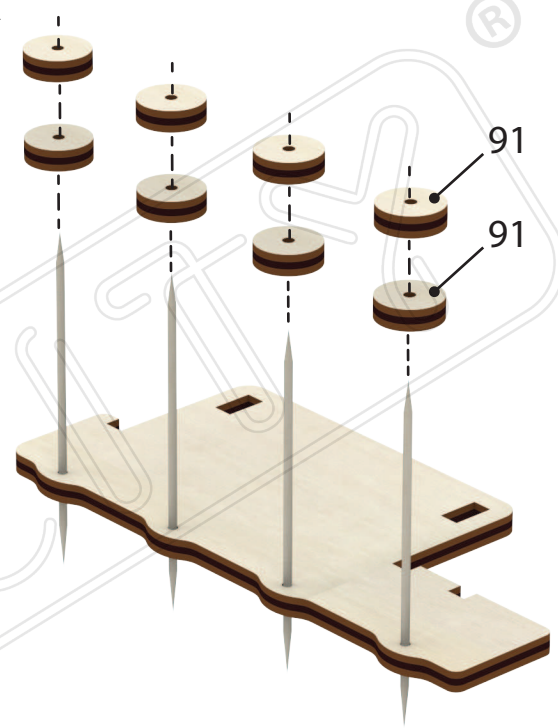

5

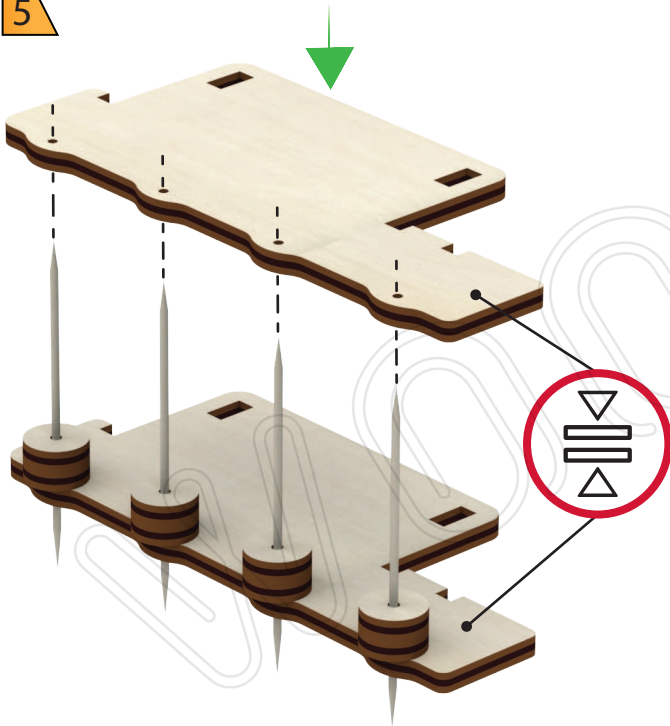

6

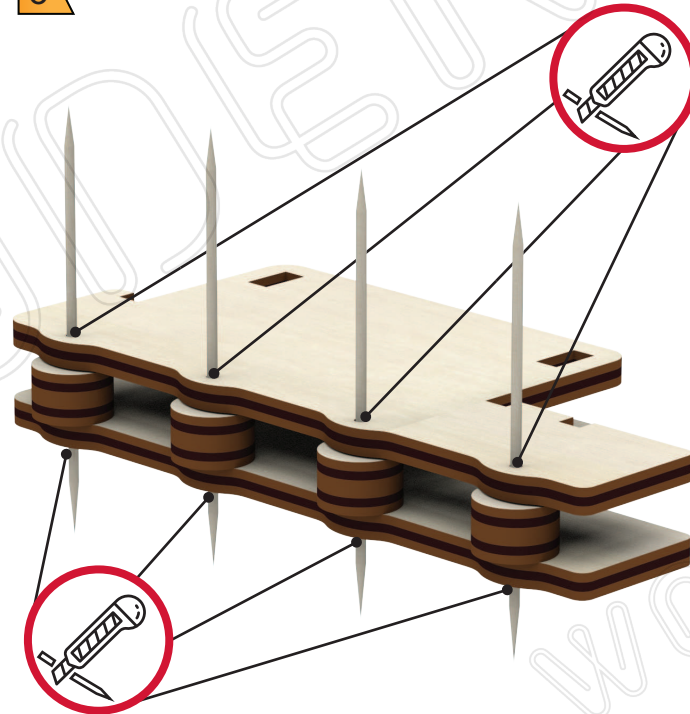

7

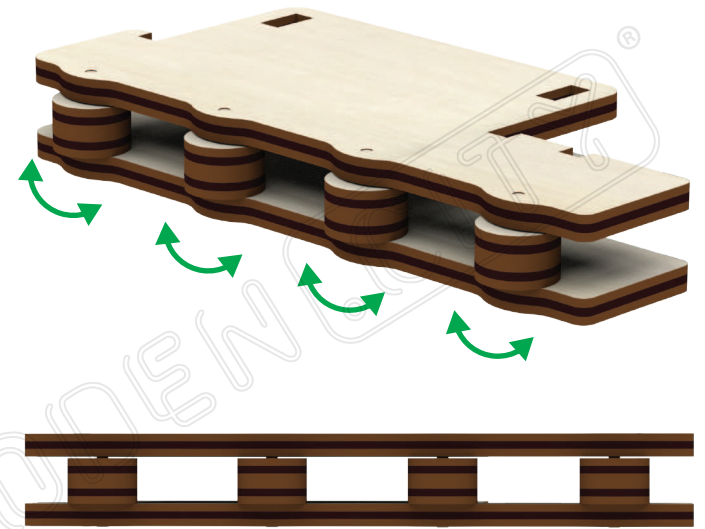

1

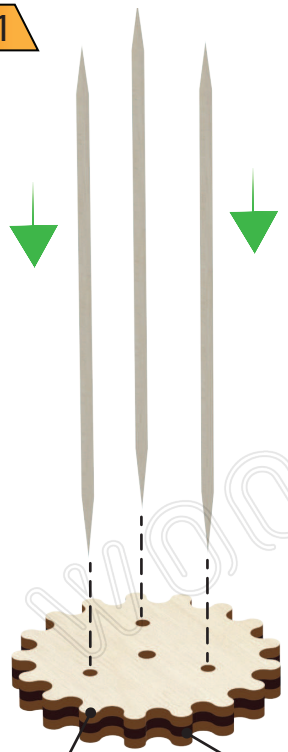

92



2

PDF Compressor Free Version

93

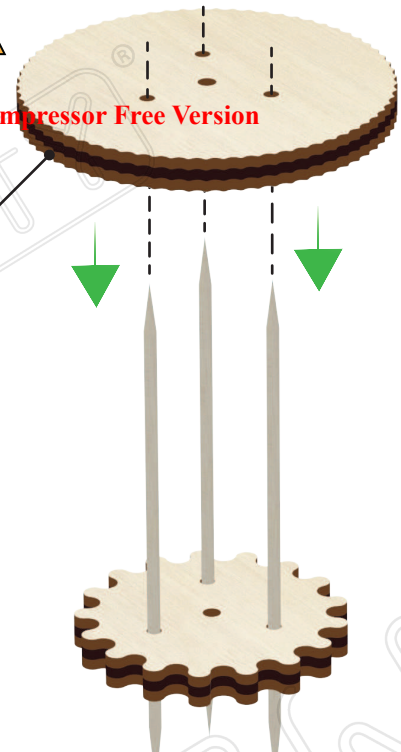

3

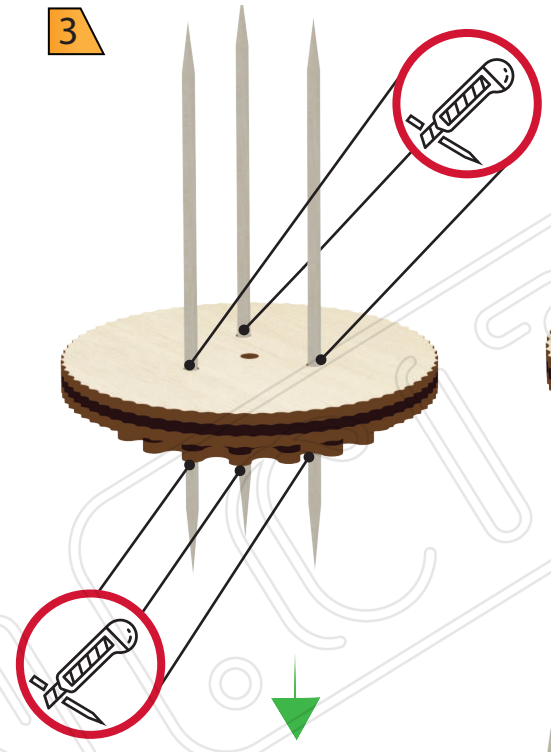

5

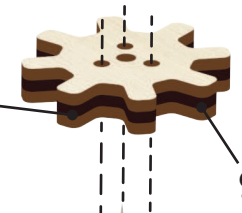

94

6

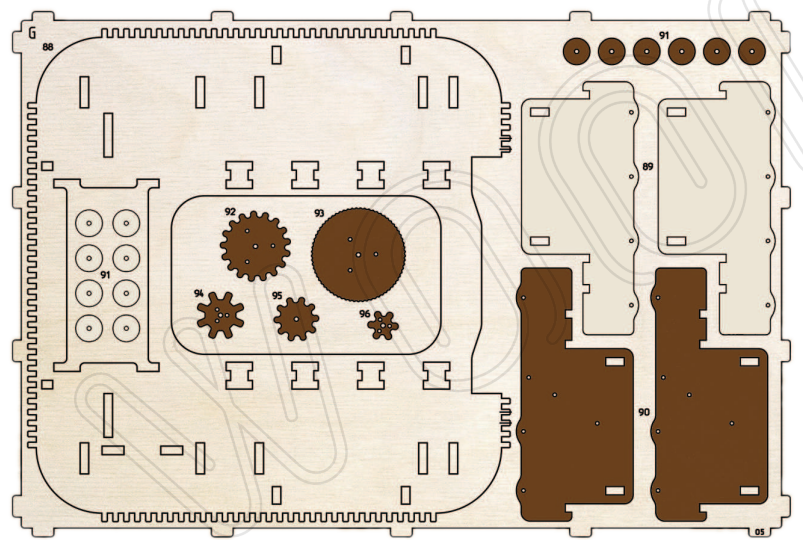
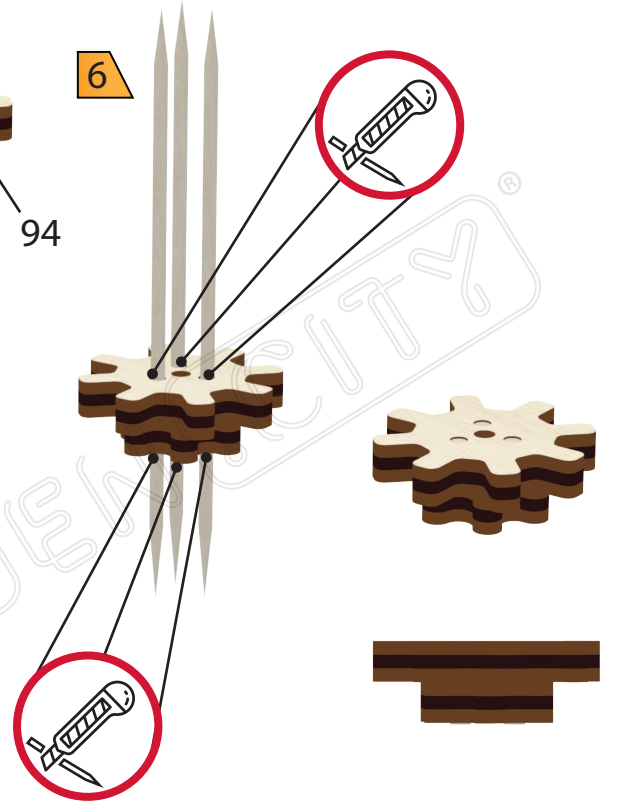

66

96

®

7

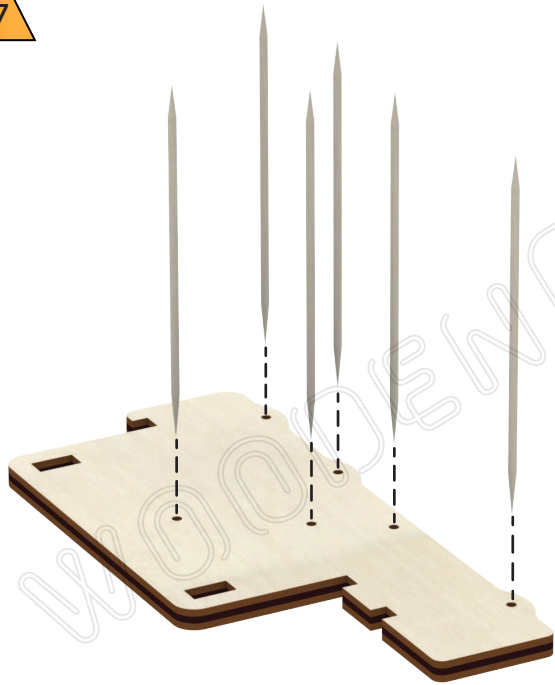

8

PDF Compressor Free Version

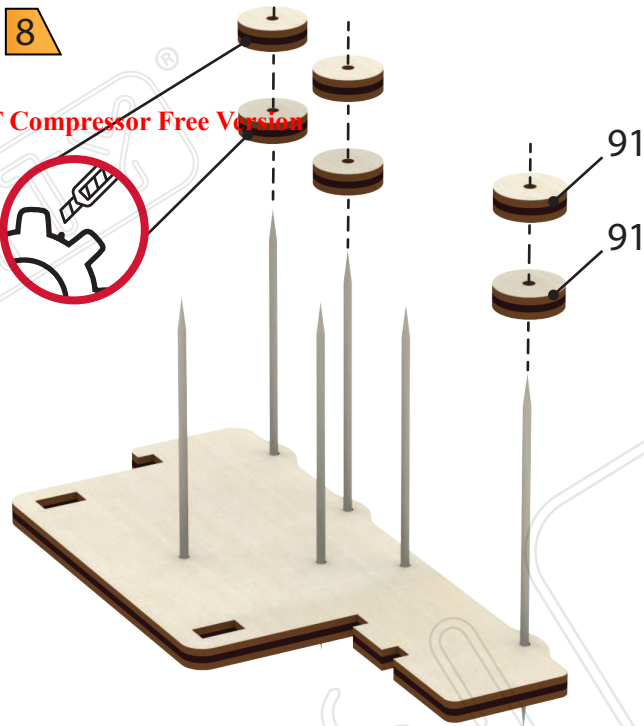

9

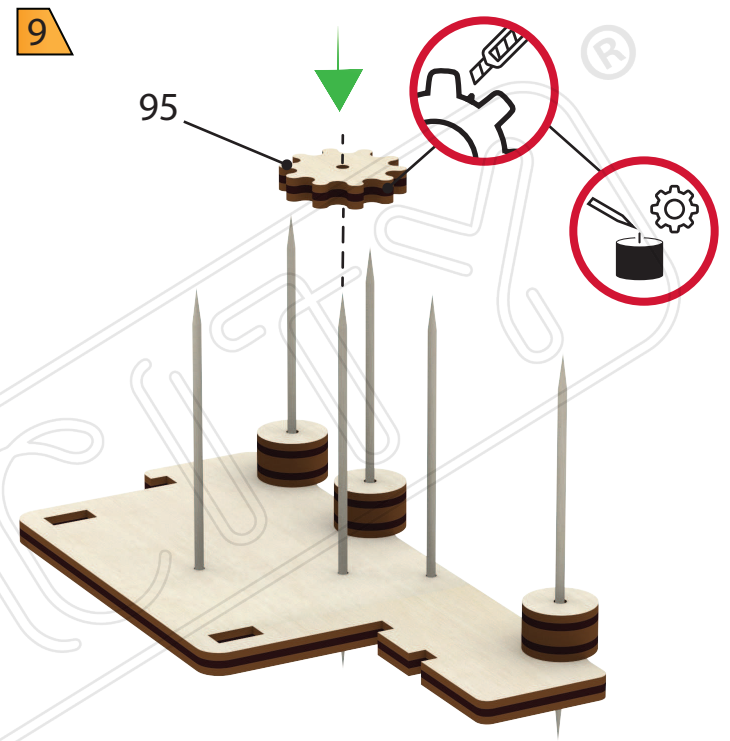

10

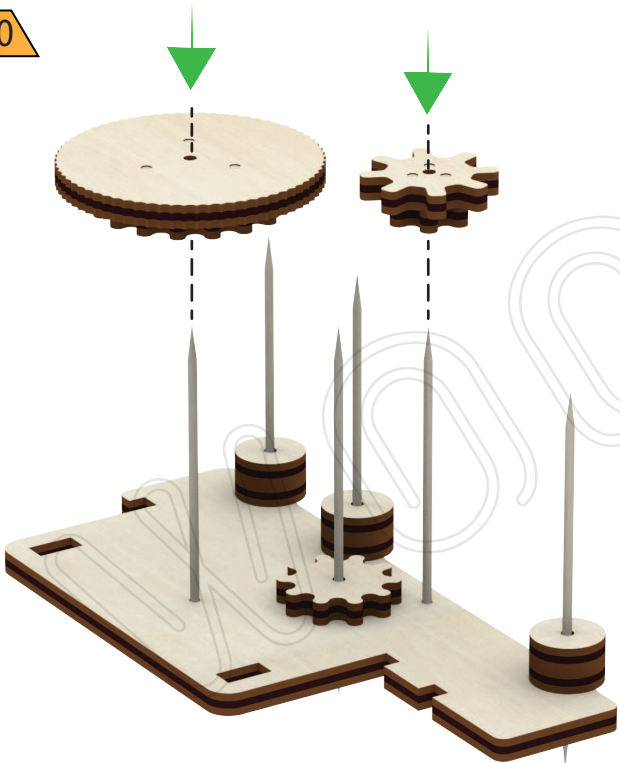

11

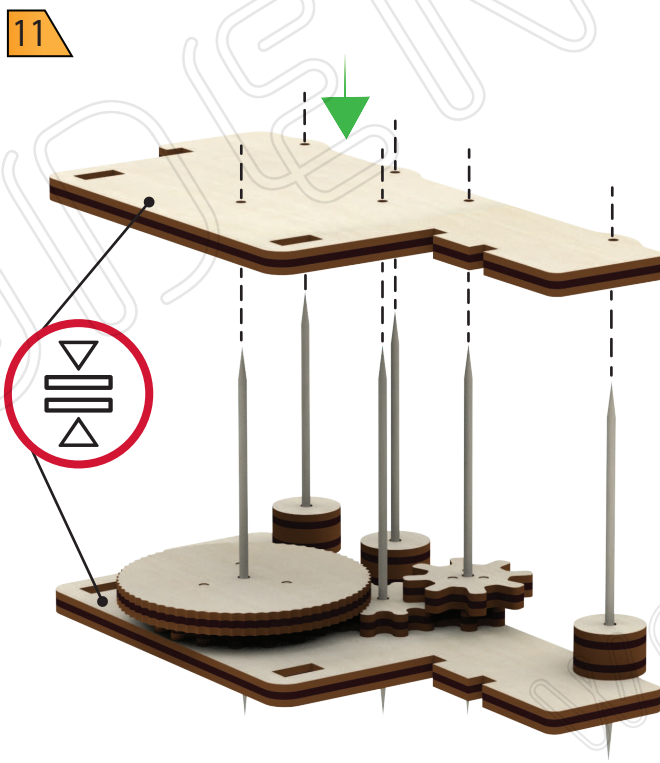

12

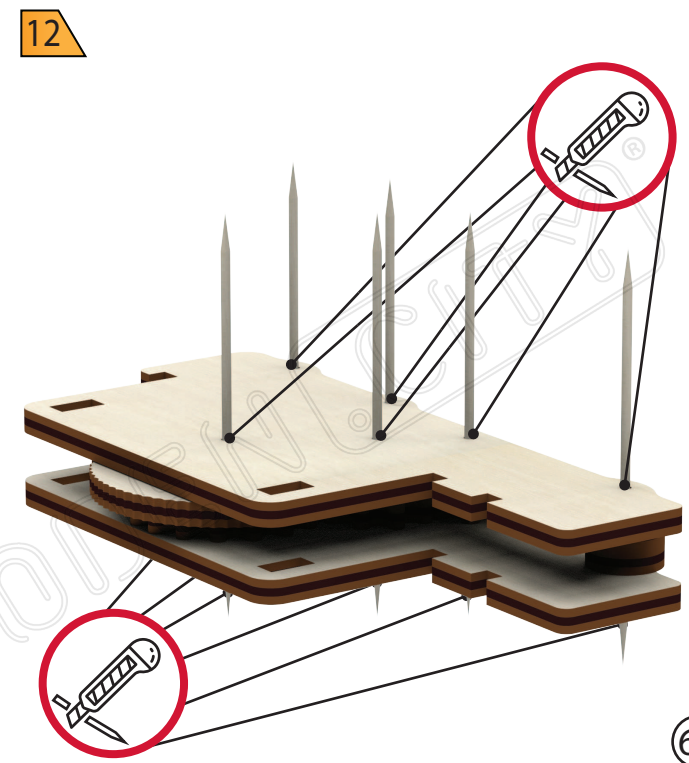

PDF Compressor Free Version

14



13

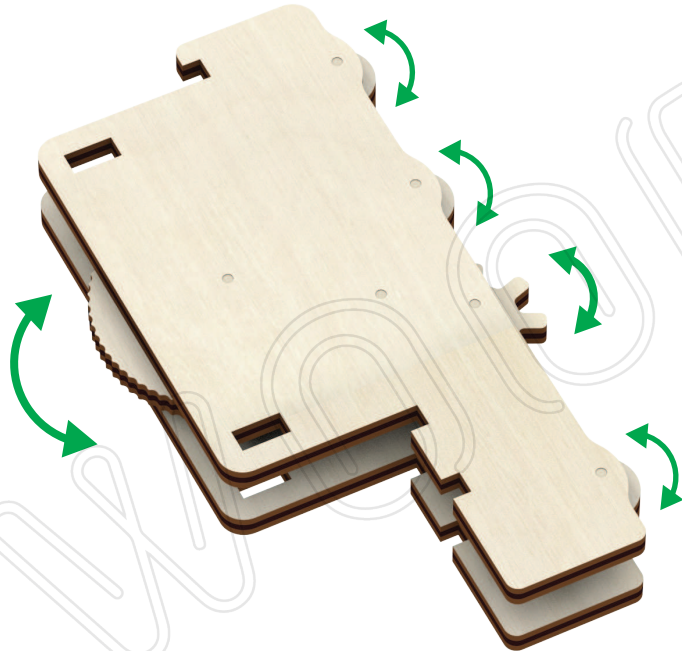

15

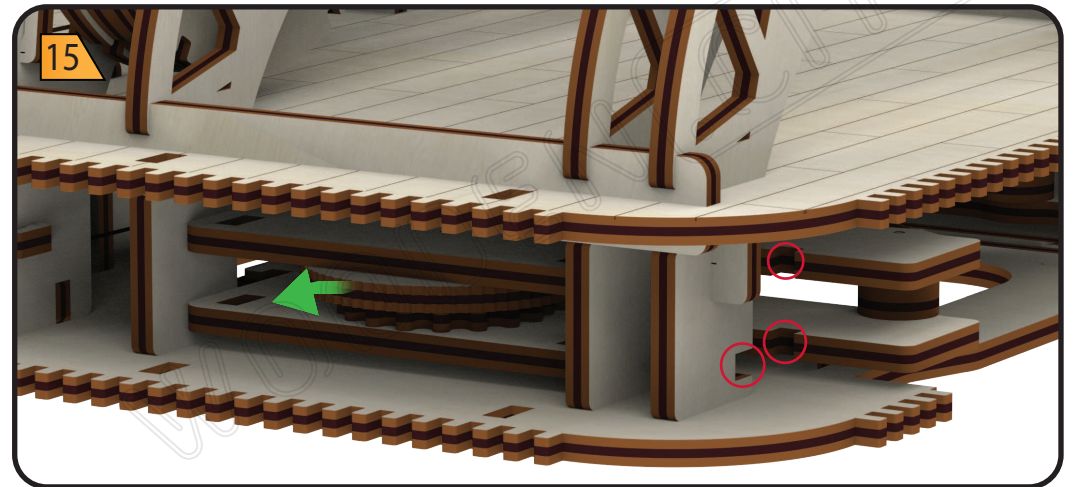



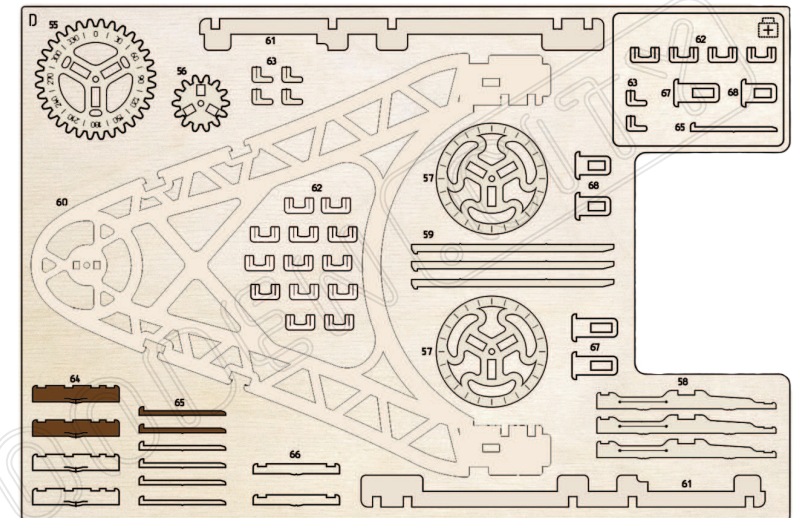
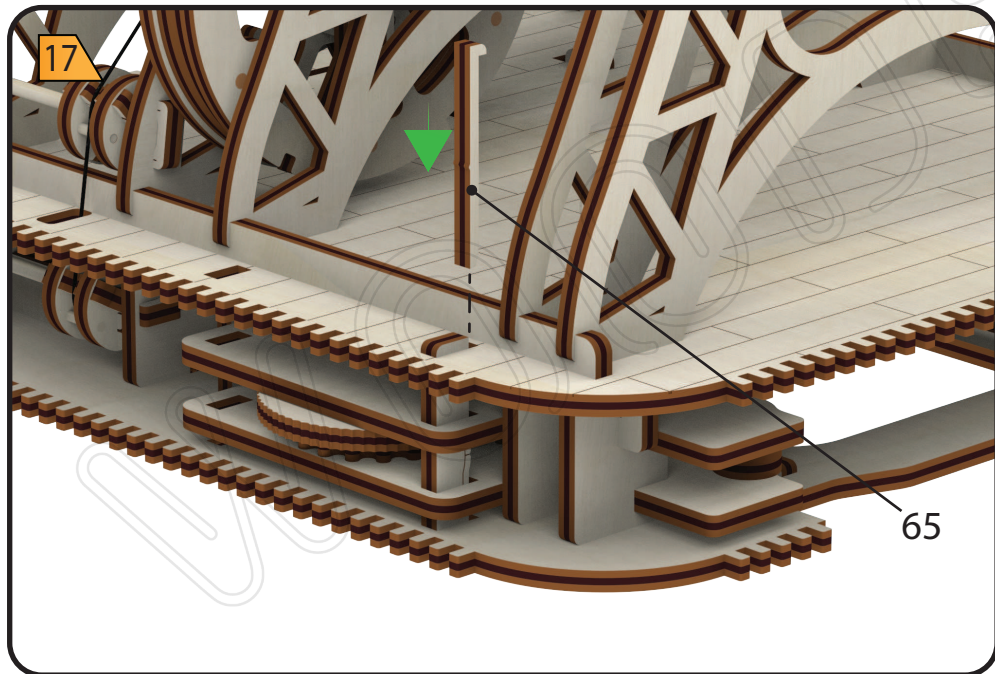
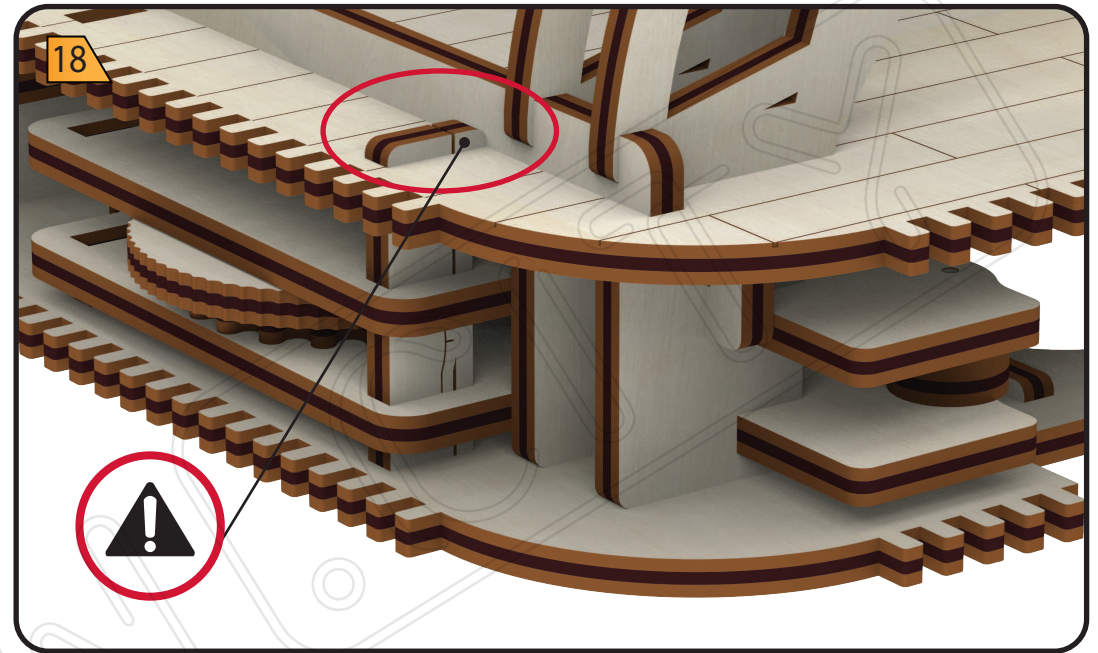
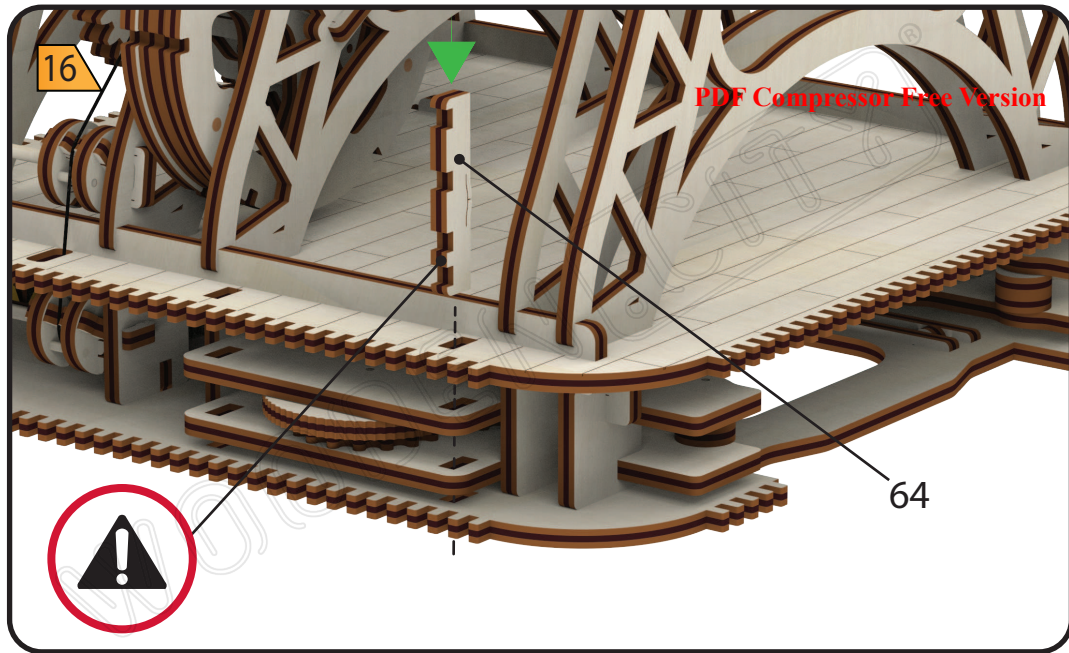

PDF Compressor Free Version

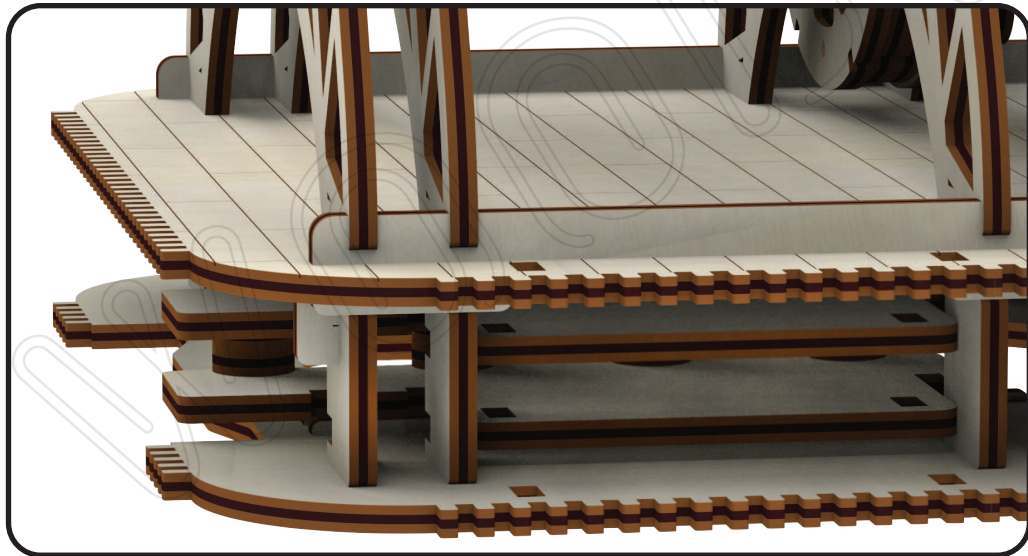
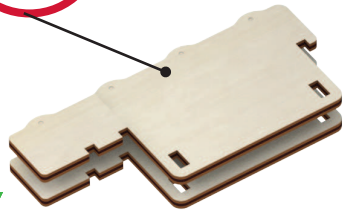

70

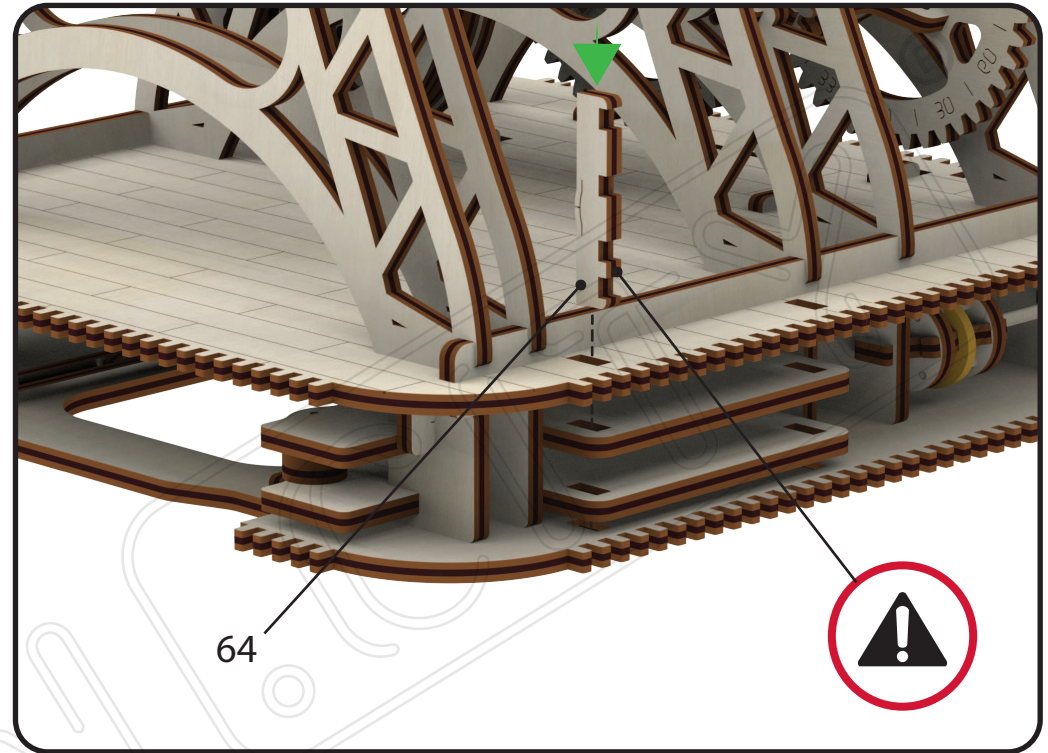

64

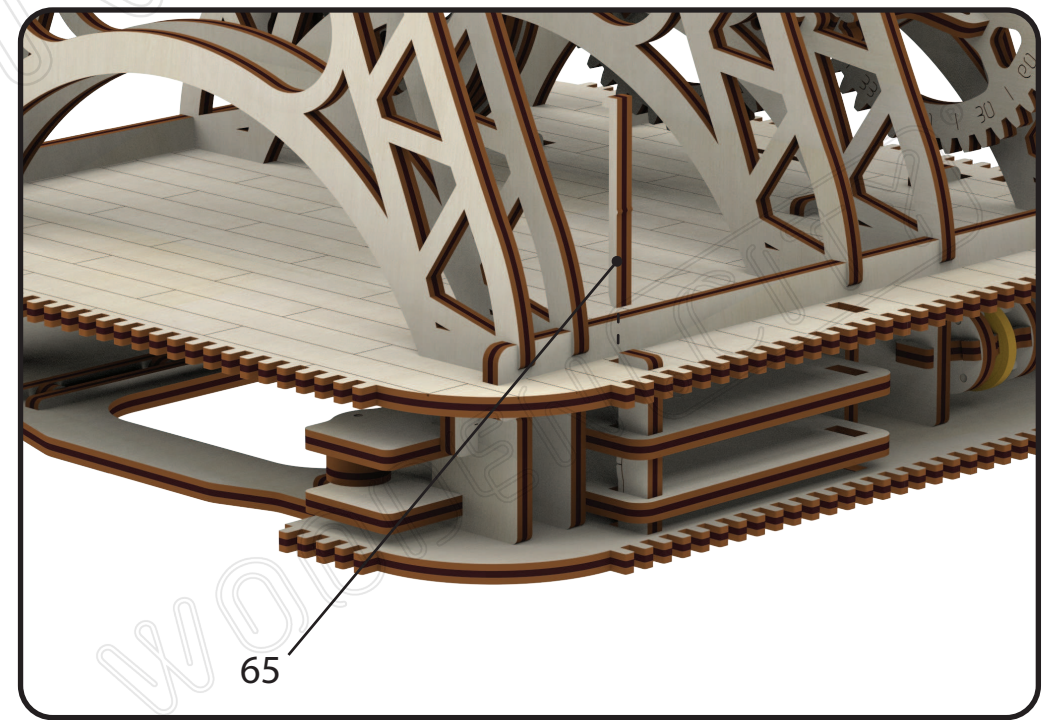

65

