

29634

SB294/ RSCX-358

## RASIERER WIEDERAUFLADBARE DREI KÖPFE

### GEBRAUCHSANLEITUNG

#### A. GERÄTEBESCHREIBUNG

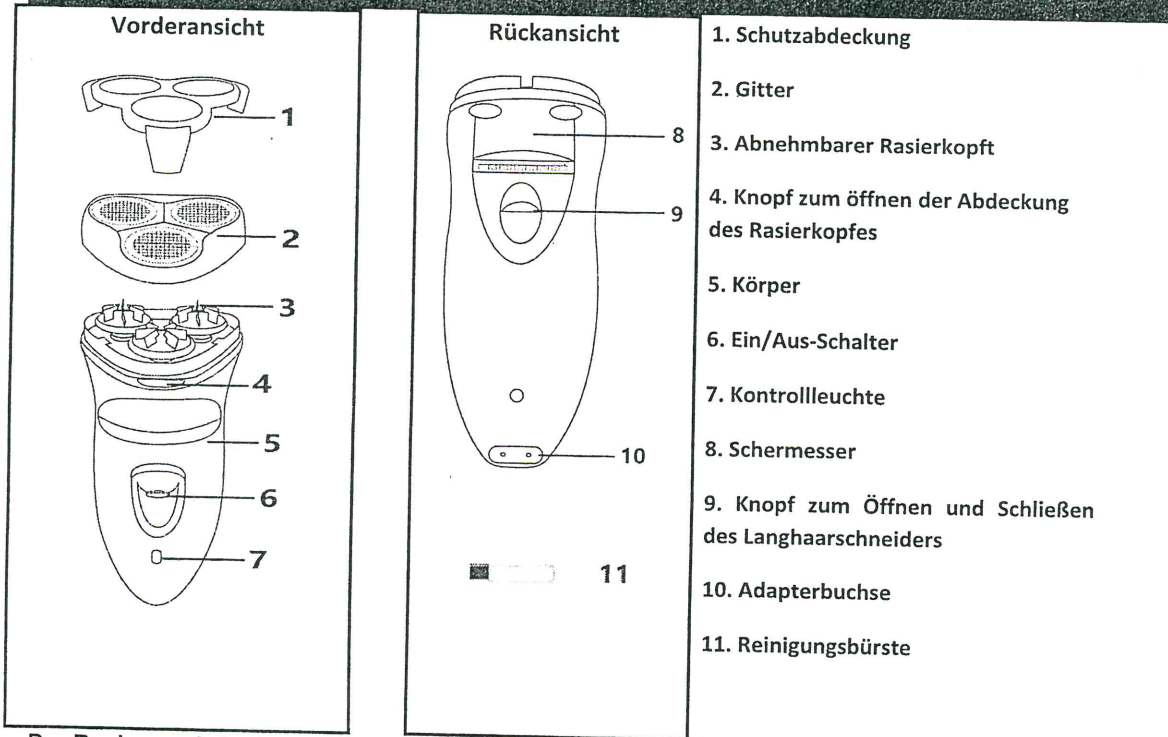

Der Rasierer wird mit einem Beutel geliefert.

#### B. TECHNISCHE DATEN

220-240V 50 Hz 3W

Batterie : Ni-Mh 1x AA 600mA / 1,2V

#### C. AUFLADEN DES RASIERERS

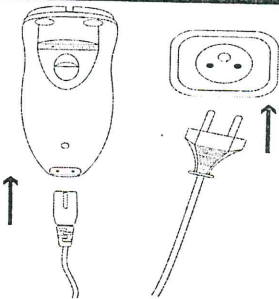

**Hinweis:** Die Ladeanzeige leuchtet grün vom Anfang bis zum Ende des Ladevorgangs.

Ladedauer: 12H

Betriebszeit nach vollständiger Aufladung : 60m

#### D. Wie Sie den Rasierapparat und Bartschneider NUTZEN

a. EINSCHALTEN DES RASIERERS

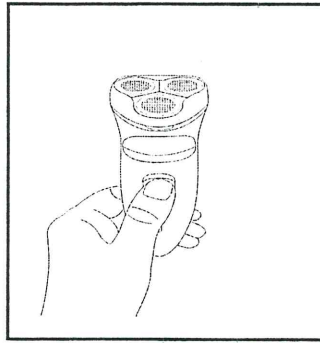
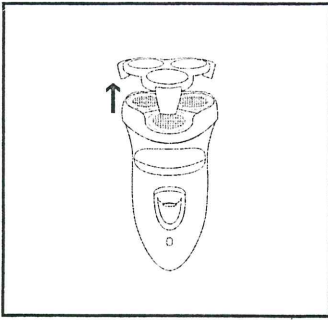

b. LANGHAARSCHNEIDER (8)

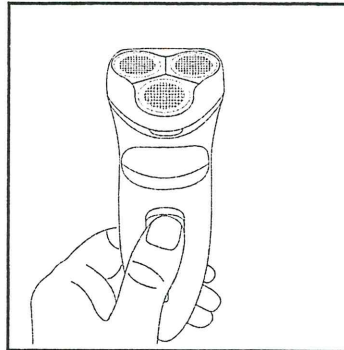
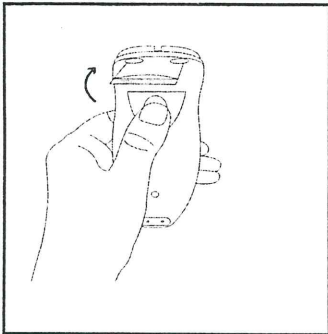

E. ACHTUNG

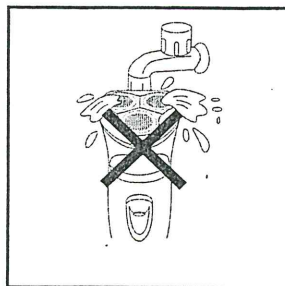
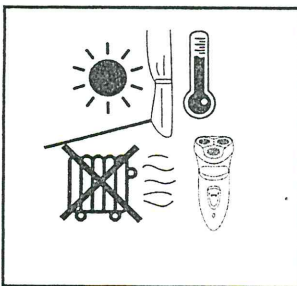
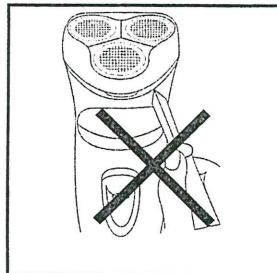
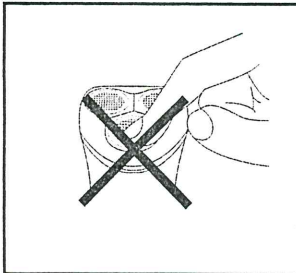

F. REINIGUNG UND PFLEGE

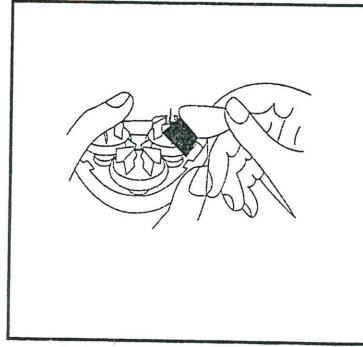
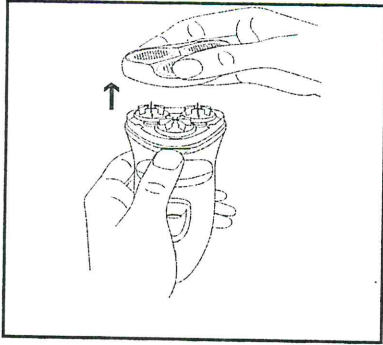



#### G. SICHERHEITSHINWEISE DEN AKKU BETTREFFEND:

- Der Akku darf nicht entfernt werden, bevor er nicht völlig entladen ist.
- Der Akku muss aus dem Gerät entfernt werden, bevor man dieses entsorgt.
- Das Gerät muss vom Strom genommen werden, wenn man den Akku entfernt. Zuerst muss der Stecker des Ladegeräts gezogen werden und anschließend der Stecker, der es mit dem Rasierer verbindet.
- Den Rasierer auf keinen Fall wieder anstecken, nachdem der Akku entfernt wurde.
- Der Akku muss sicher entsorgt werden.

#### Einzuhaltendes Verfahren zur Entfernung des Akkus

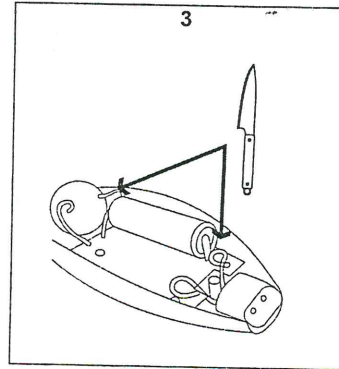
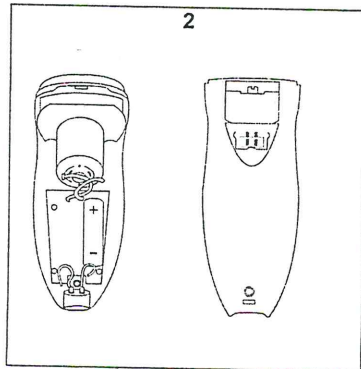
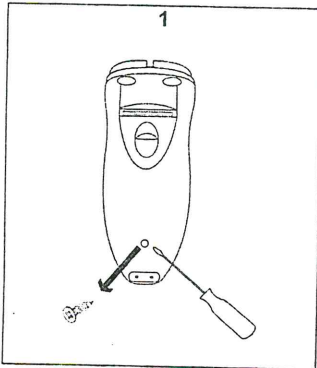
Bevor man irgendetwas macht, was mit der Entfernung der Batterie in Zusammenhang steht, informieren Sie sich über die folgenden Sicherheitsvorkehrungen und befolgen Sie sie.



 **ACHTUNG:** Dieses Gerät dürfen Sie nicht zusammen mit Ihrem Hausmüll entsorgen. Für diese Art von Produkten wird von den Gemeinden ein Getrenntsammlsystem bereitgestellt. Erkundigen Sie sich bei Ihrer Gemeindeverwaltung, um Informationen über die Standorte der Sammelstellen zu erhalten. Elektro- oder Elektronikprodukte enthalten gefährliche Substanzen, die negative Auswirkungen auf die Umwelt oder die menschliche Gesundheit haben, und müssen daher recycelt werden. Dieses Symbol gibt an, dass die Entsorgung der Elektro- und Elektronikgeräte über ein Getrenntsammlsystem erfolgt. Es stellt eine Mülltonne mit Rädern dar, die durch ein Kreuz durchgestrichen ist.

Importiert von PRODIS 1 rue de Rome 93110 ROSNY SOUS BOIS- Frankreich  
 Vermarktung durch EUROTOPS VERSAND GMBH D-40764 LANGENFELD - Deutschland  
 Hergestellt in der VRC

## 3-HEAD OPLAADBAAR SCHEERAPPARAAT

### GEBRUIKSAANWIJZING

#### A. BESCHRIJVING VAN HET APPARAAT

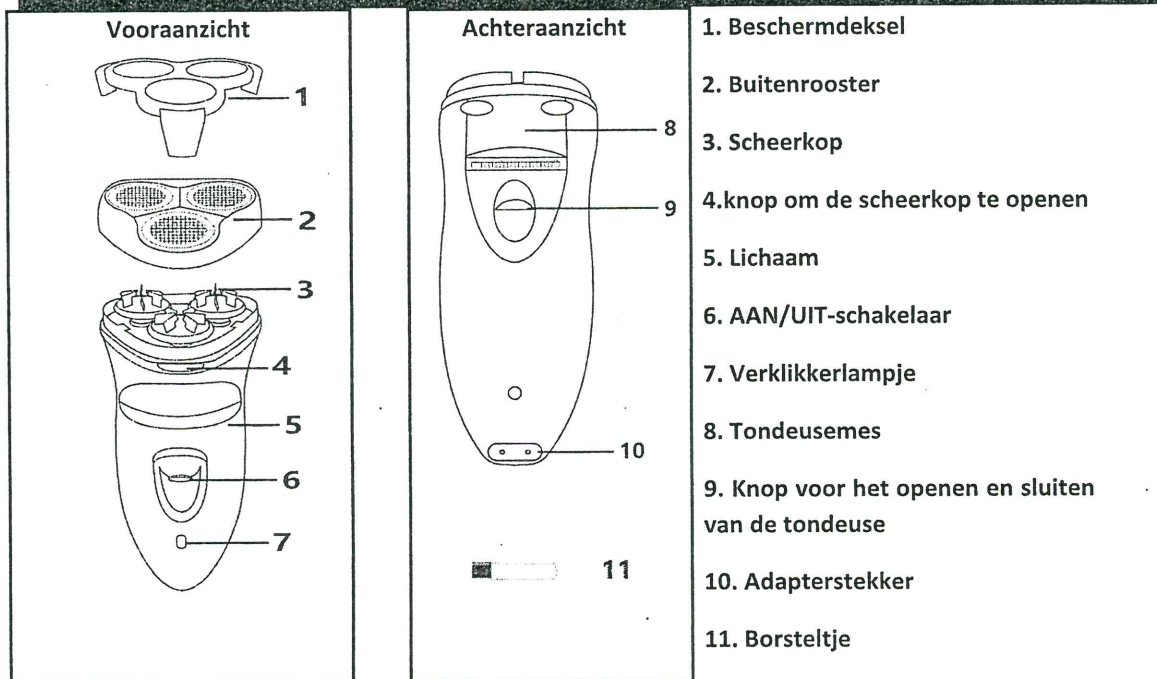

Het scheerapparaat wordt geleverd met opbergzakje.

#### B. TECHNISCHE KENMERKEN

220-240V 50 Hz 3W

Batterij : Ni-Mh 1x AA 600mA / 1,2V

#### C. HET SCHEERAPPARAAT OPLADEN

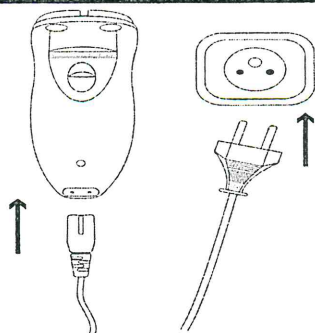

**Opmerking:** Het lampje blijft van het begin tot het einde van de oplaadsessie groen.

Oplaadtijd: 12H

Autonomie van een volledig opgeladen apparaat :  
60min

#### D. UTILISATION DU RASOIR ET DE LA TONDEUSE

a. Uw scheerapparaat aanzetten

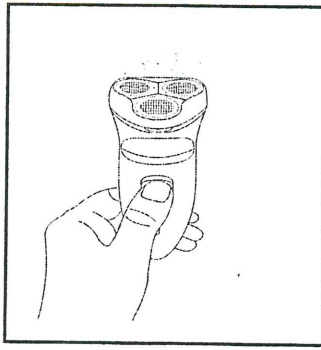
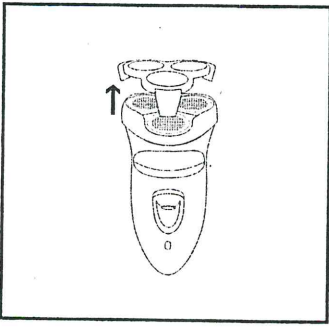

b. Trimmer (8)

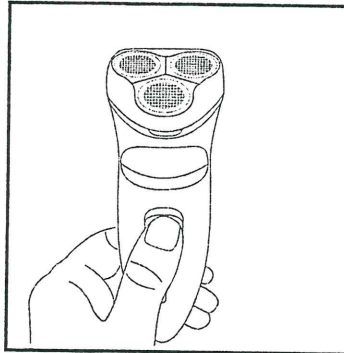
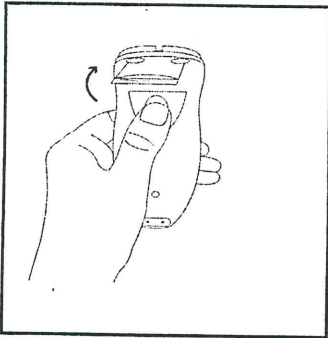

E. WAARSCHUWINGEN

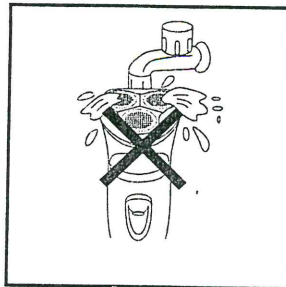
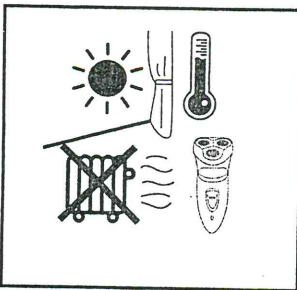
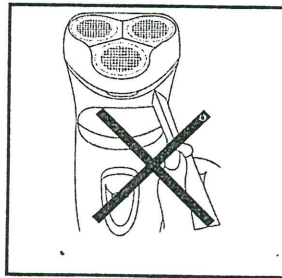
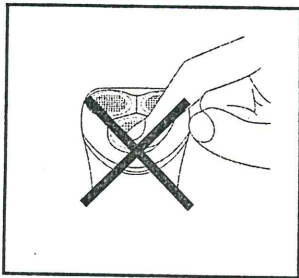

F. REINIGING EN ONDERHOUD

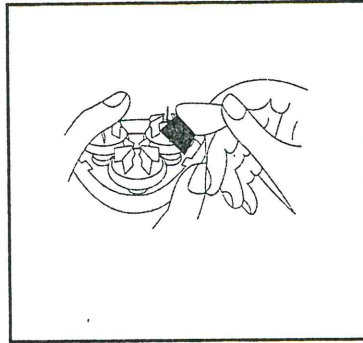
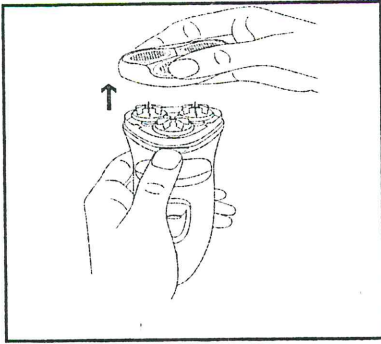



#### G. VEILIGHEIDSTIP VOOR DE BATTERIJ :

- De batterij mag niet verwijderd worden, voordat deze volledig leeg is.
- De batterij moet uit het apparaat verwijderd worden, voordat deze ter beschikking gesteld wordt.
- Als u de batterij verwijdert, moet u het apparaat afsluiten van het lichtnet. U dient het laadapparaat eerst te verwijderen en dan trekt u de stekker die verbonden is met het scheermes uit.
- Sluit het scheerapparaat nooit na het verwijderen van de batterij.
- De batterij moet op veilige wijze weggedaan worden.

#### Hoe u de batterij verwijdert

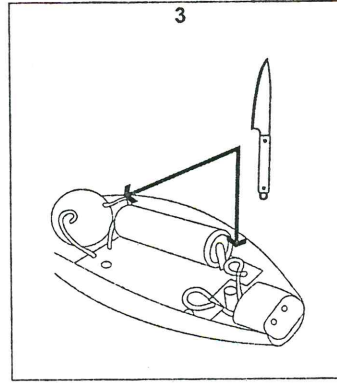
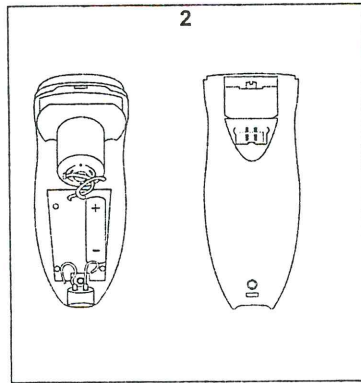
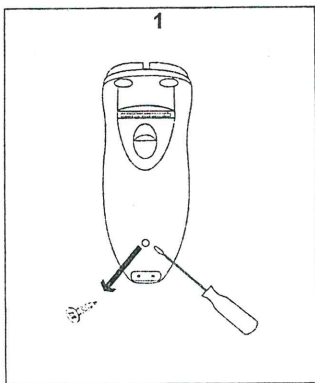
Voordat u werkt aan het verwijderen van de batterij, moet u erop letten dat de bovengenoemde veiligheidstip gevolgd wordt.



 **LET OP:** U mag dit apparaat niet wegdoen met uw huishoudafval. Uw gemeente heeft een speciaal inzamelsysteem opgezet voor dit soort producten. Vraag op uw gemeentehuis waar zich de speciaal hiervoor bestemde containers bevinden. Elektrische en elektronische producten bevatten namelijk bestanddelen en stoffen die gevaarlijk kunnen zijn voor het milieu of voor de volksgezondheid en moeten worden gerecycleerd.

Dit pictogram geeft aan dat de elektrische en elektronische apparatuur speciaal moeten worden ingezameld. Het pictogram bestaat uit een doorgekruiste container op wielen

Geïmporteerd door PRODIS SAS, 1 rue de Rome, 93110 Rosny-sous-Bois, Frankrijk  
Op de markt gebracht door EUROTOPS VERSAND GMBH D-40764 LANGENFELD, Duitsland  
Gemaakt in de VRC

## Rasoir rechargeable 3 têtes

### MODE D'EMPLOI

#### A. DESCRIPTION DU PRODUIT

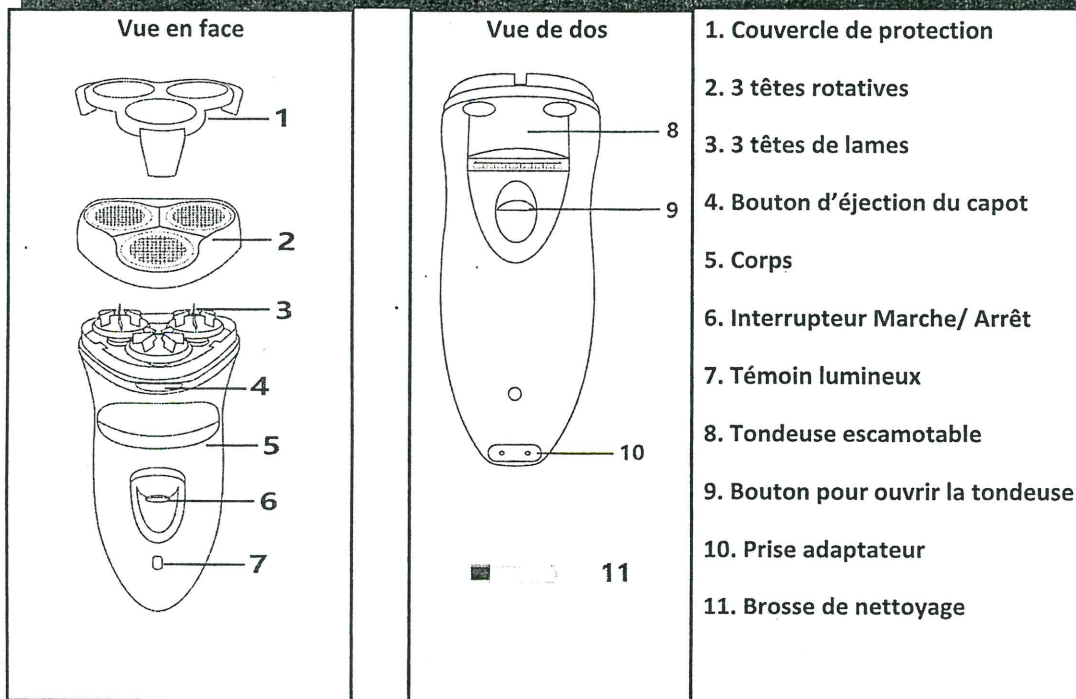

Le rasoir est livré avec une housse.

#### B. CARACTÉRISTIQUES TECHNIQUES

220-240V 50 Hz 3W

Batterie : Ni-Mh 1x AA 600mA / 1,2V

#### C. CHARGEMENT DU RASOIR

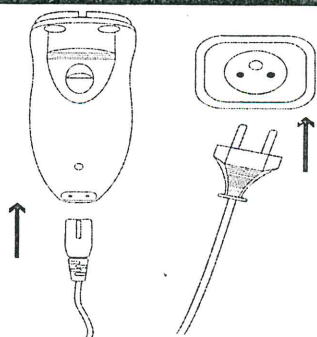

**Note :** Le voyant lors du chargement est vert du début à la fin du chargement.

Durée de charge : 12H

Autonomie après pleine charge : 60min

#### D. UTILISATION DU RASOIR ET DE LA TONDEUSE

a. Utilisation du rasoir

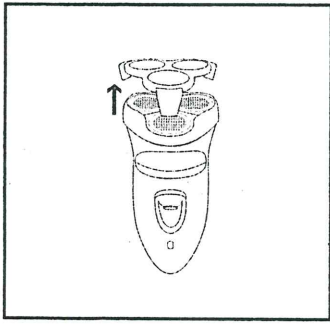

b. Utilisation de la tondeuse (8)

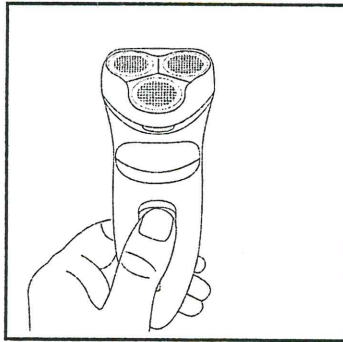
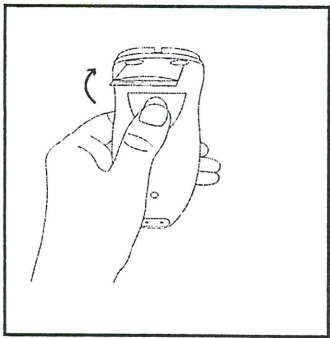

E. AVERTISSEMENTS

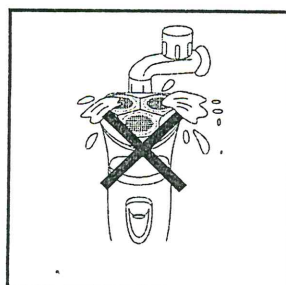
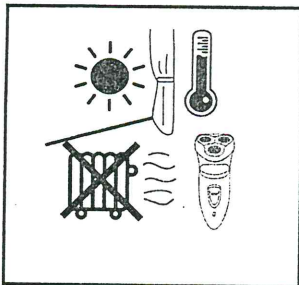
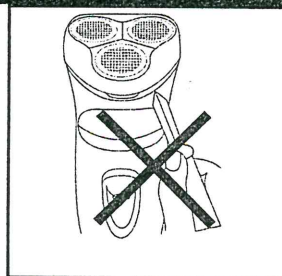
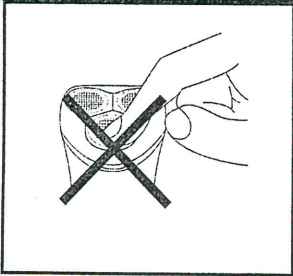



## F. MAINTENANCE

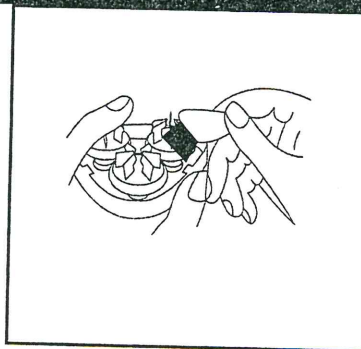
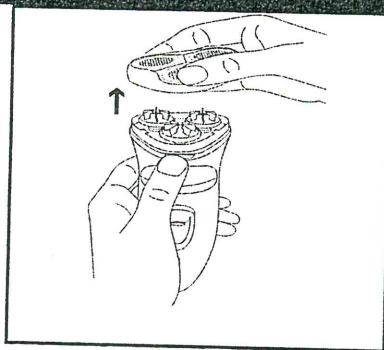



## G. AVERTISSEMENTS CONCERNANT LES PILES :

- La batterie ne doit pas être retirée tant qu'elle n'est pas complètement déchargée.
- La batterie doit être retirée de l'appareil avant que celui-ci ne soit mis au rebut.
- L'appareil doit être déconnecté du réseau d'alimentation lorsqu'on retire la batterie. Il faut débrancher le chargeur et retirer ensuite la prise qui le relie au rasoir.
- Ne rebranchez jamais le rasoir après avoir retiré la batterie.
- La batterie doit être éliminée de façon sûre. Elle doit être éliminée dans un centre de collecte sélective ; elle ne doit pas être jetée avec les déchets ménagers.

### Procédure à suivre pour retirer la batterie

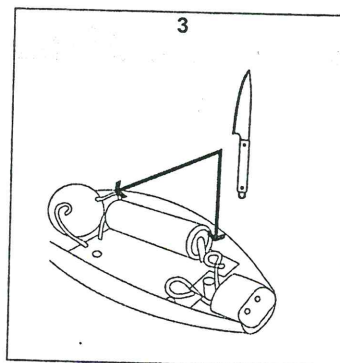
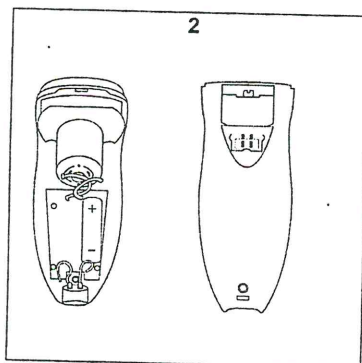
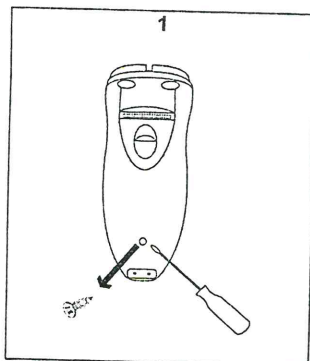
Avant de commencer toute opération relative au retrait de la batterie, veuillez prendre connaissance des consignes de sécurité stipulées ci-dessus et les suivre.



 **ATTENTION :** Vous ne devez pas vous débarrasser de cet appareil avec vos déchets ménagers. Un système de collecte sélective pour ce type de produit est mis en place par les communes, vous devez vous renseigner auprès de votre mairie afin d'en connaître les emplacements. En effet, les produits électriques et électroniques contiennent des substances dangereuses qui ont des effets néfastes sur l'environnement ou la santé humaine et doivent être recyclés. Ce symbole indique que les équipements électriques et électroniques font l'objet d'une collecte sélective, il représente une poubelle sur roues barrée d'une croix.

Importé par PRODIS SAS, 1 rue de Rome, 93110 Rosny-sous-Bois, France  
Commercialisé par EUROTOPS VERSAND GMBH D-40764 LANGENFELD, Allemagne   
Fabriqué en RPC

SB294/ RSCX-358

## 3-HODERS OPPLADBAR ELEKTRISK BARBERMASKIN

### BRUKSANVISNING

#### A. BESKRIVELSE

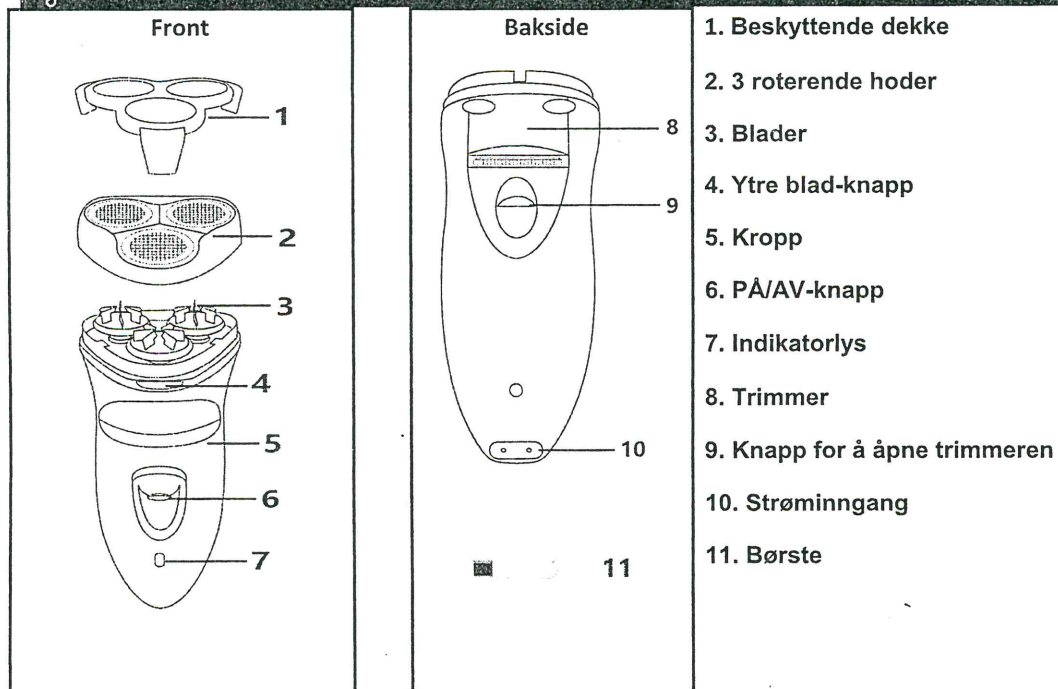

Barbermaskinen kommer med en pose.

#### B. TEKNISKE SPESIFIKASJONER

220-240V 50 Hz 3W

Batteri: Ni-Mh 1x AA 600mA / 1,2V

#### C. LADING AV BARBERMASKINEN

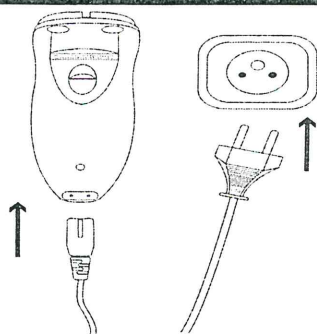

**Merk:** Indikatoren er grønn ved begynnelse og slutt.

Ladetid: 12 timer

Brukstid når fullstendig oppladet: 60 min

#### D. SLIK BRUKER DU BARBERMASKINEN OG TRIMMEREN

a. Slå på barbermaskinen

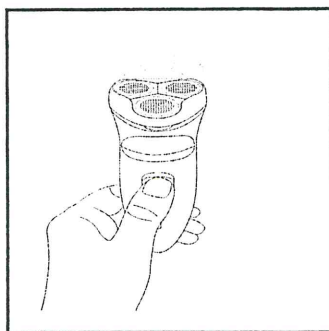
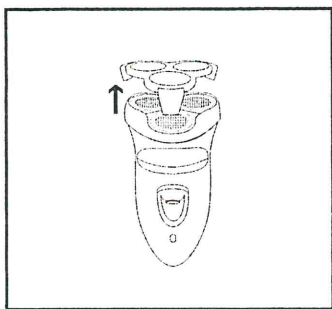

b. Trimmer (8)

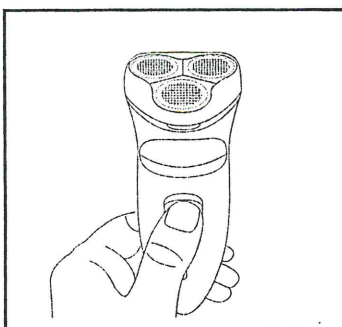
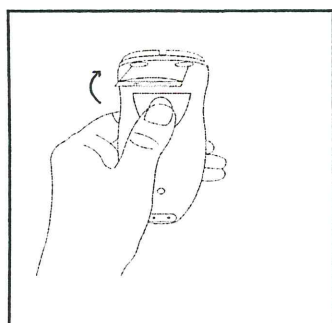

E. ADVARSLER

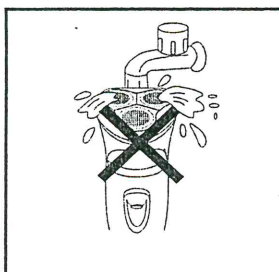
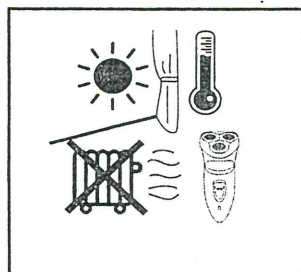
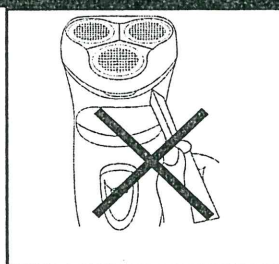
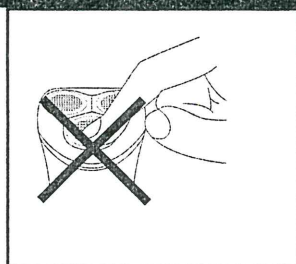

F. VEDLIKEHOLD

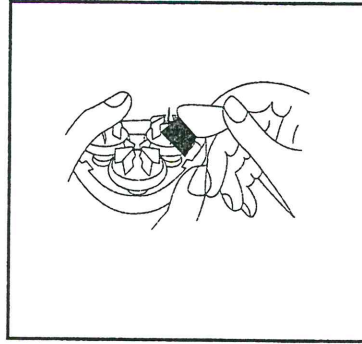
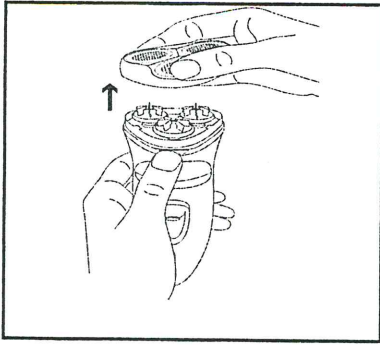



#### G. SIKKERHETSINSTRUKSJONER FOR BATTERI:

- Batteriet må ikke fjernes før det er helt tomt.
- Batteriet må fjernes fra apparatet før det kastes.
- Apparatet må være koblet fra strømforsyningen når du fjerner batteriet. Du må ta laderen ut av stikkontakten og barbermaskinen.
- Ikke koble til barbermaskinen igjen etter at batteriet er fjernet.
- Batteriet må avhendes på trygt vis.

#### Prosedyre for å fjerne batteriet

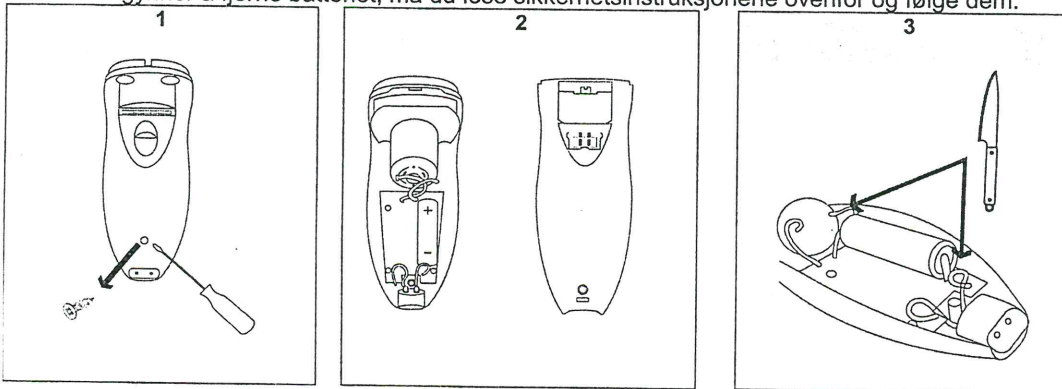
Før du begynner å fjerne batteriet, må du lese sikkerhetsinstruksjonene ovenfor og følge dem.



 **ADVARSEL:** Du må ikke kaste apparatet i husholdningsavfallet. Kommunen har et selektivt innsamlingssystem for denne typen produkter. Ta kontakt med kommunen din for å finne ut hvor og hvordan innsamlingen fungerer. Disse begrensningene følges på grunn av de farlige stoffene elektriske og elektroniske apparater inneholder, som kan ha skadelig påvirkning på miljøet og menneskelig helse, og må derfor resirkuleres.

Dette symbolet indikerer at elektriske og elektroniske apparater samles inn selektivt. Symbolet viser en søppelboks krysset ut med et X-symbol.

Importert av PRODIS SAS, 1 rue de Rome, 93110 Rosny-sous-Bois, Frankrike  
Markedsført av EUROTUPS VERSAND GMBH D-40764 LANGENFELD, Tyskland  
Laget i Kina

## 3-HEAD RECHARGEABLE ELECTRIC SHAVER INSTRUCTION MANUAL

### A. DESCRIPTION

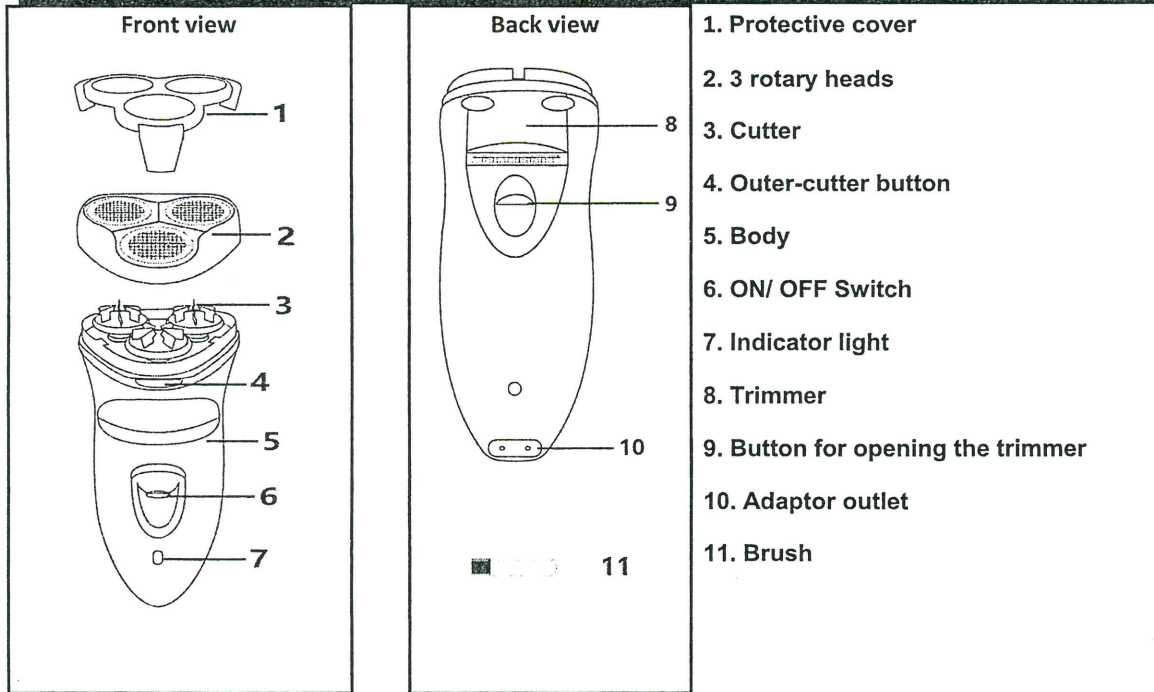

The shaver is supplied with a pouch.

### B. TECHNICAL SPECIFICATIONS

220-240V 50 Hz 3W  
Battery : Ni-Mh 1x AA 600mA / 1,2V

### C. CHARGING YOUR SHAVER

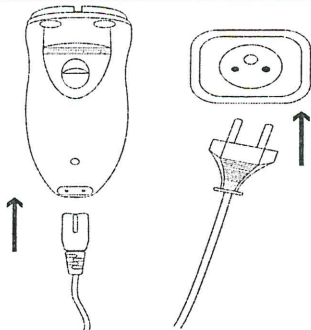

**Note :** The indicator remains green at the beginning and at the end.

Charging time : 12H

Autonomy after full charge : 60m

**D. HOW TO USE THE SHAVER AND TRIMMER**

**a. Turning on your shaver**

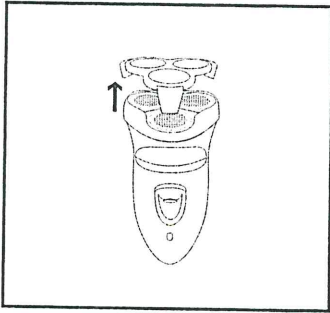

**b. Trimmer (8)**

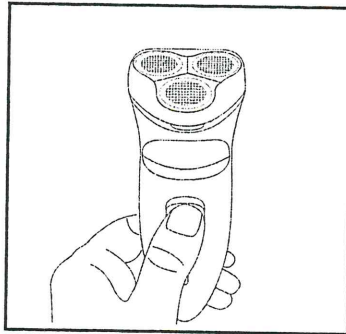
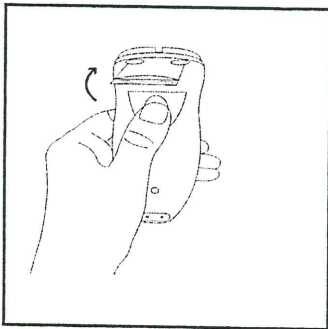

**E. WARNINGS**

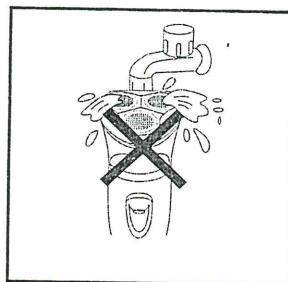
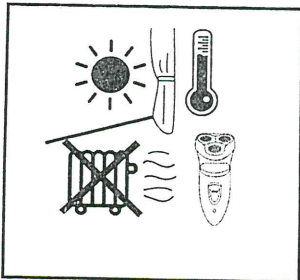
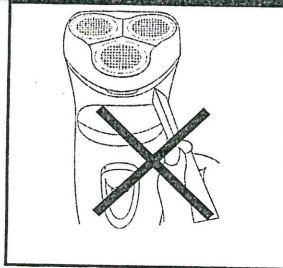
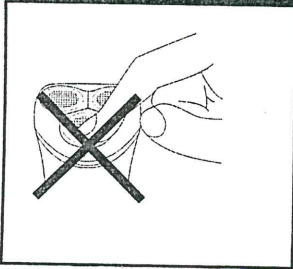

## F. MAINTAINANCE

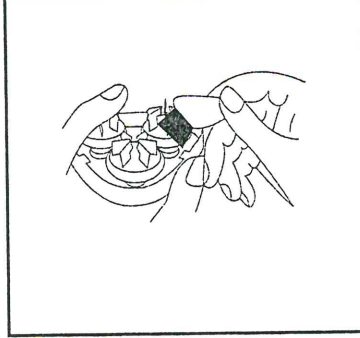
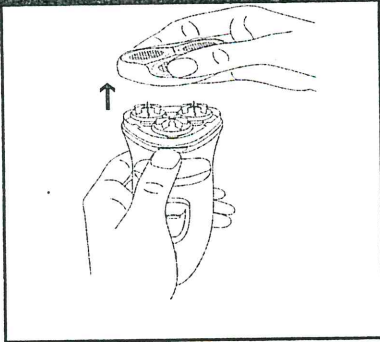

## G. SAFE INSTRUCTIONS FOR BATTERY:

- The battery should not be removed until it is not completely discharged.
- The battery must be removed from the appliance before it is scrapped.
- The appliance must be disconnected from the mains supply when removing the battery. You should unplug the charger and then remove the plug that connects to the shaver.
- Do not plug the shaver after removing the battery.
- The battery must be disposed of safely.

### Procedure to remove the battery

Before starting any operation on the removal of the battery, please read the safety instructions provide above and follow it.

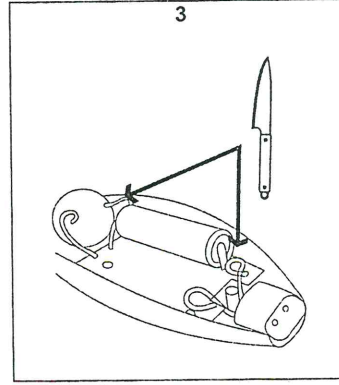
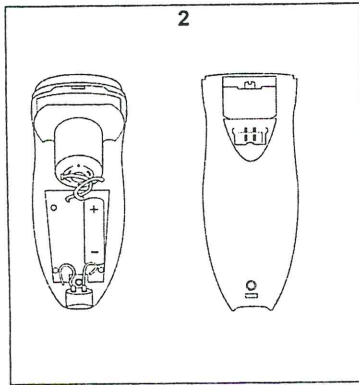
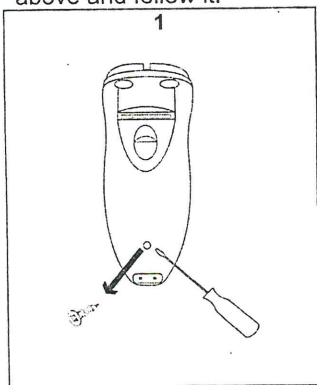

**WARNING:** You should not dispose of this device with your household waste. A selective collection system for this type of product is implemented by your local authorities. Please contact your local authorities to find out how and where collection takes place. These restrictions apply because electrical and electronic devices contain dangerous substances that have harmful effects on the environment or on human health and must be recycled.

This symbol indicates that electrical and electronic devices are collected selectively. The symbol shows a waste container crossed out with an X symbol.

Imported by PRODIS SAS, 1 rue de Rome, 93110 Rosny-sous-Bois, France  
Marketed by EUROTUPS VERSAND GMBH D-40764 LANGENFELD, Germany  
Made in PRC